



D E S I G N

hydroflora® 
da wächst Lebensfreude



2024

INDEX

WHO WE ARE	8
LET'S CREATE	9

ELEGANT SERIES	10
OCEANA COLLECTION	12
LUXE LITE COLLECTION	20
METALLIC COLLECTION	36

SMART SERIES	48
BASIC COLLECTION	50
ECOLINE COLLECTION	54
TIMELESS COLLECTION	66
LINE-UP COLLECTION	76

SOLID SERIES	82
POLYSTONE COLLECTION	84
POLYSTONE COATED COLLECTION	102
TERRAZZO COLLECTION	114
NUCAST® COLLECTION	118
NATURESCAST® COLLECTION	122
RAINDROP COLLECTION	128
VERTICAL RIB COLLECTION	134

TREND SERIES	138
DUNE COLLECTION	140
GRADIENT COLLECTION	144
OPUS COLLECTION	156
LAVA COLLECTION	164
FACETS COLLECTION	176
ANGLE COLLECTION	180
VOGUE COLLECTION	184

ACCESSORIES SERIES	188
LINER COLLECTION	190
ECOLINE ACCESSORIES	60
TIMELESS ACCESSORIES	71
GRADIENT ACCESSOIRES	147



Photo: Luxe Lite Universe Layer Partner Bronze

ICONS













-  INDOOR
-  OUTDOOR
-  UV RESISTANT
-  FROST RESISTANT
-  WATERPROOF
-  LIGHTWEIGHT
-  HANDMADE
-  RECYCLED MATERIAL
-  RAISED BOTTOM
-  WITH LINER
-  WITH DRAINAGE HOLE
-  RAL + BAQ COLOURS



Photo: Opus Raw Partner Silver

WHO WE ARE

NL Baq staat voor hoogwaardige kwaliteit plantenbakken, waar vanaf het ontwerp tot en met de productie aandacht is besteed aan detail en afwerking. Door gebruik te maken van verschillende materialen heeft iedere Baq plantenbak zijn eigen unieke uitstraling, wat de collectie zeer divers maakt: van eigentijds tot tijdloos, van stoer en ruig tot elegant en verfijnd, van kleurrijk tot minimalistisch. Voor ieder interieur en iedere plant is er een passende plantenbak. Welke serie je ook kiest, met een Baq plantenbak plaats je altijd een opvallende verschijning in het interieur.

DE Baq steht für eine Palette hochwertiger Pflanzgefäßen, bei denen vom Entwurf bis zur Fertigung auf jedes Detail sowie beste Verarbeitung geachtet wurde. Durch die Kombination mehrerer Werkstoffe besitzt jeder Baq Pflanzgefäß eine eigene, einzigartige Ausstrahlung und bietet die Kollektion eine große Vielfalt: von modern bis zeitlos, von wuchtig und rustikal bis elegant und raffiniert, von farbenreich bis minimalistisch. Für jeden Einrichtungsstil und jede Pflanze gibt es einen passenden Pflanzgefäß. Ganz gleich, auf welche Serie die Wahl fällt: Ein Baq Pflanzgefäß ist in jedem Raum eine auffallende Erscheinung.

EN Baq stands for high-quality planters that are meticulously designed and expertly crafted. Available in a wide range of materials, each Baq planter has its own unique look, which makes for a highly diverse collection. Ranging from contemporary to timeless, from rugged to refined, and from bright colours to subtle minimalism. There's a planter for every plant and interior. Whichever model you choose, a Baq planter will make for a striking addition to your interior.

FR Baq est synonyme de bacs à plantes de haute qualité, où l'attention a été portée sur les détails et la finition, de la conception à la production. En utilisant différents matériaux, chaque bac à plantes affiche son propre look, ce qui rend la collection très variée : du contemporain au intemporel, du solide et brut au élégant et raffiné, très coloré ou minimaliste. Il existe un bac à plantes pour chaque intérieur et chaque plante. Quelle que soit la série que vous choisissiez, Un bac à plantes Baq est toujours un objet qui attire le regard sur l'intérieur.



Photo: Luxe Lite Universe Moon Globe Bronze

Biophilic - eine natürliche Lebensumgebung erschaffen!

Wohlfühlen steht in allen Lebensbereichen hoch im Kurs. Pflanzen sind ein unverzichtbarer Teil in unserer natürlichen Lebensumgebung. Wir werten mit ihnen Innenräume und Außenflächen auf. Als eigener Lebensraum wird ein Pflanzgefäß benötigt. Dies ist jetzt vereinbar mit einem organischen und modernen Design. In der richtigen Größe, Form, Optik und Material, wird es selbst zum Designobjekt und nimmt, - über die pure Funktion hinaus - skulpturalen Charakter an.

Den Formen, Farben, Oberflächentexturen und Materialien sind keine Grenzen gesetzt. Für jede Designwelt, jedes Geschmacksgenre finden sich unterschiedliche Lösungen. Lassen Sie sich entführen in eine facettenreiche Welt der biophilic Pflanzgefäße. Die meisten werden in Handarbeit hergestellt und sind deshalb als Unikat anzusehen. Natürliche Materialien in Verbindung mit Verbundwerkstoffen ergeben leichte, robuste, nachhaltige und stabile Pflanzgefäße in einer Stein- oder Naturoptik. Oder wählen Sie glatte, glänzende oder verspielte Oberflächen, um die Natur in Ihrem Umfeld in Szene zu setzen und lassen Sie Ihre Lebensfreude wachsen. Wir wünschen viel Vergnügen.

Ihre Hydroflora



Wir von Hydroflora bieten Ihnen eine rundum Beratung. Von Pflanzgefäßen, passenden Pflanzen, Begrünungskonzepten, vertikalen Pflanz-, Mooswände, mobile Pflanzen- und Moosraumteilern im Innenbereich. Für Außen bieten wir Ihnen Terrassen- und Fassadenbegrünungen, um Ihr Umfeld natürlich zu gestalten. Und schließlich für alle Leistungen den entsprechenden Service, um die Langlebigkeit zu gewährleisten.

Ob es sich dabei um Maßnahmen für die Luftverbesserung, Luftfeuchtigkeitserhöhung, Verbesserung der Gesundheit zu Hause oder am Arbeitsplatz, Akustikreduktion, Wohlfühlempfinden handelt, wir greifen auf über 50 Jahre Erfahrung zurück.

Biophilic Design Konzepte, um die Konnektivität der Nutzer mit der natürlichen Umgebung durch die Verwendung der direkten Natur, der indirekten Natur, sowie der Raum- und Platzbedingungen zu verbessern ist unser Bestreben. Dies fördert das Wohlempfinden und führt somit zu höherer Kreativität und stärkerer Leistungsfähigkeit. Soziale Kompetenz und Teamfähigkeit entwickeln sich so eigenständig.





Photo: Polystone Nathan James Partner Pueter Champagne

LET'S CREATE

NL Met vernieuwende ideeën en slimme toepassingen creëren we verrassende designs en handige accessoires die de uitstraling van je plant en interieur versterken. Het natuurlijk groen komt nog beter tot zijn recht in een Baq plantenbak, wat het verblijf in een ruimte veraangenaamt. Het sfeervolle geheel inspireert en prikkelt de creatieve geest.

DE Mit innovativen Ideen und intelligenten Anwendungen gestalten wir überraschende Designs und praktische Accessoires, durch die Ihre Pflanze ebenso wie das Interieur mehr Ausstrahlung gewinnen. Das natürliche Grün kommt in einem Baq-Pflanzgefäß noch besser zur Geltung, was den Aufenthalt im Raum angenehmer macht. Das aparte Ensemble wirkt auf den kreativen Geist inspirierend und anregend.

EN With innovative ideas and smart new techniques, we create surprising designs and practical accessories that make your plants pop while lifting up your interior. A Baq planter will bring out the natural beauty of your greenery, making your home an even more pleasant place to stay. The whole inspires and stimulates the creative mind.

FR Avec des idées innovantes et des utilisations intelligentes, nous créons de superbes designs et des accessoires pratiques qui mettent en valeur le look de votre plante et de votre intérieur. Le bac à plantes Baq accentue le vert naturel, ce qui rend la pièce agréable à vivre. L'ensemble chaleureux inspire et stimule l'esprit créatif.



Photo: Gradient Lee Couple Matt Coffee + Gradient Lee Partner Matt Coffee

ELEGANT SERIES

COLLECTIONS

OCEANA

LUXE LITE

METALLIC

NL De Elegant-serie onderscheidt zich door exclusieve en luxueuze designs die tot in perfectie zijn afgewerkt. Deze plantenbakken zijn ware eyecatchers die niet over het hoofd gezien worden.

DE Die Serie Elegant zeichnet sich durch exklusive und luxuriöse Designs in perfekter Verarbeitung aus. Diese Pflanzgefäße sind echte Hingucker, die nicht übersehen werden können.

EN The Elegant series is distinguished by exclusive and luxurious designs that are finished to perfection. The planters in this series are genuine eye-catchers.

FR La série Elegant se caractérise par des designs exclusifs et luxueux à la finition parfaite. Ces bacs à plantes sont de véritables accroche-regards qui ne passent jamais inaperçus.

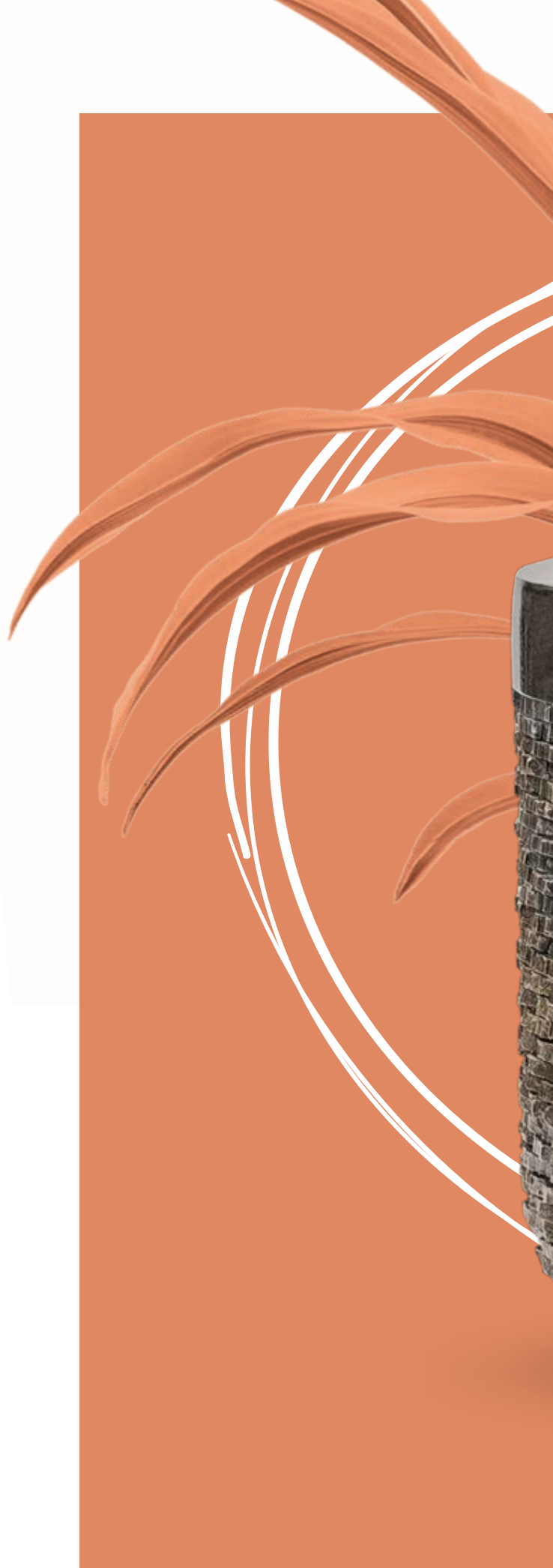



LET'S CREATE



OCEANA COLLECTION

NL De Oceana is een parel voor in het interieur. Deze opvallende verschijning is gemaakt van Polyresin, een mix van gemalen steen en vloeibare kunstharz. Vervolgens wordt de plantenbak met de hand versierd met oesterschelpen of RVS. Diverse modellen zijn voorzien van een inzetbak en de kleinere tafelformen zijn geheel waterdicht. Door het gebruik van natuurlijke materialen kunnen getoonde kleuren afwijken van de werkelijkheid.

DE Der Oceana ist eine Perle für den Innenbereich. Diese auffallende Erscheinung wird aus Polyresin hergestellt, einer Mischung aus Kunstharz und gemahlenem Stein. Der fertige Pflanzgefäße wird von Hand mit Austernschalen oder Edelstahl dekoriert. Einige Modelle haben eine separate Einsatz, während die kleineren Tischmodelle wasserdicht ausgeführt sind. Durch die Verwendung natürlicher Materialien kann die tatsächliche Farbe von den hier gezeigten Farben abweichen.

EN The Oceana is a real pearl for any interior. This striking object is made of polyresin, a mixture of ground stone and liquid synthetic resin. The planter has been decorated by hand with oyster shells or stainless steel. Several of the models come with a liner, and the smaller tabletop models are completely waterproof. Because the Oceana is made using natural materials, the colours in the image may differ from reality.

FR L'Oceana est un joyau pour votre l'intérieur. Ce bac à plantes remarquable est fabriqué à partir de polyrésine, un mélange de pierre broyée et de résine synthétique liquide. Le bac à plantes est ensuite décorée à la main avec des coquilles d'huîtres ou de l'acier inoxydable. Plusieurs modèles sont dotés d'une pochette et les plus petits modèles sont complètement étanches. En raison de l'utilisation de matériaux naturels, les couleurs présentées peuvent différer de la réalité.



Photo: Oceana Pearl Couple White



Photo: Oceana Pearl Partner Brown

OCEANA COLLECTION



A



C



B



D

OCEANA PEARL

A

BOWL BROWN



ART. CODE 60CEBB306 ↔ / ↙ ↘

40 32 24

C

OVAL BROWN



ART. CODE 60CEBB206 ↔ / ↙ ↘

60 26 30

B

COUPLE BROWN



ART. CODE 60CECB107 ↻ ↺ ↻

30 42 37
60CECB807 38 50 45
60CECB908 46 60 55

D

PARTNER BROWN



ART. CODE 60CEPB507 ↻ ↺ ↻

30 41 90





Photo: Oceana Pearl Couple White

OCEANA COLLECTION



A



C



B



D

OCEANA PEARL

A BOWL WHITE
ART. CODE ↔ ↙ ↘
 60CEBW313 40 32 24

C OVAL WHITE
ART. CODE ↔ ↙ ↘
 60CEBW213 60 26 30

B COUPLE WHITE
ART. CODE ⊗ ⊘ ⊚
 60CECW613 14 17 15
 60CECW114 30 42 37
 60CECW814 38 50 45

D PARTNER WHITE
ART. CODE ⊗ ⊘ ⊚
 60CEPW414 27 35 70
 60CEPW415 30 41 90





Photo: Oceana Pearl Abalone Couple Blue + Oceana Pearl Partner Blue

OCEANA COLLECTION



OCEANA PEARL

A COUPLE BLUE
ART. CODE 60CEPB126

13	17	15

OCEANA PEARL ABALONE

C COUPLE BLUE
ART. CODE 60CECA307

30	42	37

B PARTNER BLUE
ART. CODE 60CEPB129

27	35	70
60CEPB130	30	41 90



LUXE LITE COLLECTION

NL De Luxe Lite-collectie is samengesteld met aandacht voor detail en dat is te zien aan de prachtige afwerking. Elke plantenbak heeft zijn eigen unieke uitstraling. De plantenbakken zijn gemaakt van een met glasvezelversterkte kunststof of fiberclay. Deze materialen zijn zeer sterk en tegelijkertijd licht van gewicht.

DE Die erstklassige Verarbeitung beweist, dass die Luxe Lite-Kollektion mit großer Liebe zum Detail zusammengestellt wurde. Jedes Pflanzgefäß hat seine eigene, individuelle Ausstrahlung. Die Pflanzgefäße bestehen aus einem glasfaserverstärkten Kunststoff oder aus Fiberclay. Diese Materialien sind ausgesprochen stark und dennoch leichtgewichtig.

EN The Luxe Lite collection has been compiled with attention to detail, which is reflected in the beautiful finish. Each planter has its own unique appearance. The planters are made of glass fibre reinforced plastic or fibre clay. These materials are very strong, yet very lightweight.

FR La collection Luxe Lite est composée avec un grand soin des détails, ce que l'on remarque à la finition magnifique. Chaque bac à plantes a son apparence unique. Les bacs à plantes sont fabriqués en matière plastique renforcée de fibres de verre ou fiberclay. Ces matériaux sont très solide, mais en même temps très léger.



NL Gebruik een Baq inzethoes om deze plantenbak waterdicht te maken.

DE Verwenden Sie eine Baq-Einsatz, um diesen Pflanzgefäß wasserdicht zu machen.

EN Use a Baq liner to make this planter watertight.

FR Utilisez une pochette de Baq pour rendre cette bac à plantes étanche.



Photo: Luxe Lite Universe Layer Globe Bronze



Photo: Luxe Lite Universe Comet Rectangle Bronze

LUXE LITE COLLECTION

LUXE LITE UNIVERSE COMET

A GLOBE BRONZE

ART. CODE	⊙	⊗	⊔
6LXLACG20	18	28	20
6LXLACG24	21	33	24
6LXLACG27	25	39	27
6LXLACG32	30	45	32

B PARTNER BRONZE

ART. CODE	⊙	⊗	⊔
6LXLACC53	32	38	69

C PARTNER STRAIGHT BRONZE

ART. CODE	↔	↗	⊔
6LXLACB07	27	33	70
6LXLACB09	30	36	90
6LXLACB12	31	38	110

D RECTANGLE BRONZE

ART. CODE	↔	↗	⊔
6LXLACR55	100	30	50



E CYLINDER BRONZE

ART. CODE	⊙	⊗	⊔
6LXLACC22	19	23	22
6LXLACC27	24	28	27
6LXLACC31	28	33	31
6LXLACC38	35	40	38





Photo: Luxe Lite Universe Layer Partner Bronze

LUXE LITE COLLECTION

LUXE LITE UNIVERSE LAYER

A GLOBE BRONZE

ART. CODE	⊙	⊘	∩
6LXLALG20	18	28	20
6LXLALG24	21	33	24
6LXLALG27	25	39	27
6LXLALG32	30	45	32



B PARTNER BRONZE

ART. CODE	⊙	⊘	∩
6LXLALC53	33	38	69
6LXLALB07	28	33	70
6LXLALB09	30	36	90
6LXLALB12	31	38	110



C RECTANGLE BRONZE

ART. CODE	↔	↙	∩
6LXLALR55	100	30	50



D OVAL BRONZE

ART. CODE	↔	↙	∩
6LXLALO10	45	20	20
6LXLALO12	60	20	20
6LXLALO13	50	22	40



E CYLINDER BRONZE

ART. CODE	⊙	⊘	∩
6LXLACL22	19	23	22
6LXLACL27	24	28	27
6LXLALC31	28	33	31
6LXLALC38	38	40	38





Photo: Luxe Lite Universe Moon Globe Bronze

LUXE LITE COLLECTION

A



B



C



D

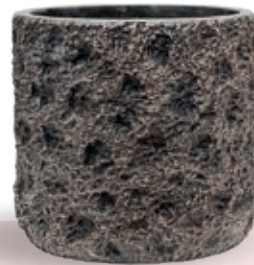

LUXE LITE UNIVERSE MOON

A

GLOBE BRONZE

ART. CODE	⊙	☑	☒
6LXLAMG20	18	28	20
6LXLAMG24	24	33	24
6LXLAMG27	25	39	27
6LXLAMG32	30	45	32

C

RECTANGLE BRONZE

ART. CODE	↔	↗	☒
6LXLAMR55	100	30	50

B

PARTNER BRONZE

ART. CODE	⊙	☑	☒
6LXLAMC53	33	38	69
6LXLAMB07	28	33	70
6LXLAMB09	30	36	90
6LXLAMB12	31	38	110

D

CYLINDER BRONZE

ART. CODE	⊙	☑	☒
6LXLAMC22	19	23	22
6LXLAMC27	24	28	28
6LXLAMC31	28	33	31
6LXLAMC38	35	40	38





Photo: Luxe Lite Universe Waterfall Oval Bronze

LUXE LITE COLLECTION



LUXE LITE UNIVERSE WATERFALL

A GLOBE BRONZE

ART. CODE	⊗	⊘	⊔
6LXLAWG20	18	28	20
6LXLAWG24	21	33	24
6LXLAWG27	25	39	27
6LXLAWG32	30	45	32

B PARTNER BRONZE

ART. CODE	⊗	⊘	⊔
6LXLAWB07	28	33	70
6LXLAWB09	30	36	90
6LXLAWB12	31	38	110



C CYLINDER BRONZE

ART. CODE	⊗	⊘	⊔
6LXLAWC22	19	23	22
6LXLAWC27	24	28	27
6LXLAWC31	28	33	31
6LXLAWC38	37	40	38

D OVAL BRONZE

ART. CODE	⊗	⊘	⊔
6LXLAWO02	45	20	20
6LXLAWO04	60	20	20
6LXLAWO05	50	22	40

LUXE LITE UNIVERSE WAVE

E GLOBE BRONZE

ART. CODE	⊗	⊘	⊔
6LXLAVG27	25	39	27
6LXLAVG32	30	45	32

F PARTNER BRONZE

ART. CODE	⊗	⊘	⊔
6LXLAVB07	29	33	70
6LXLAVB09	29	36	90
6LXLAVB12	30	38	110

G CYLINDER BRONZE

ART. CODE	⊗	⊘	⊔
6LXLAVC31	28	33	31
6LXLAVC38	35	40	38





Photo: Luxe Lite Universe Wrinkle Cylinder Bronze

LUXE LITE COLLECTION



LUXE LITE UNIVERSE WRINKLE

A GLOBE BRONZE

ART. CODE	⊙	⊗	⊠
6LXLAXG20	18	28	20
6LXLAXG24	21	33	24
6LXLAXG27	25	39	27
6LXLAXG32	30	45	32

C CYLINDER BRONZE

ART. CODE	⊙	⊗	⊠
6LXLAXC22	19	23	22
6LXLAXC27	24	28	27
6LXLAXC31	28	33	31
6LXLAXC38	35	40	38

B PARTNER BRONZE

ART. CODE	⊙	⊗	⊠
6LXLAXB07	30	34	75
6LXLAXB09	33	36	90
6LXLAXB12	35	38	105

D OVAL BRONZE

ART. CODE	⊙	⊗	⊠
6LXLAXO06	45	20	20
6LXLAXO08	60	20	20
6LXLAXO09	50	22	40





Photo: Luxe Lite Glossy Partner White-Gold

LUXE LITE COLLECTION



LUXE LITE GLOSSY

A **GLOBE WHITE-GOLD**

ART. CODE			
6LXLGWD27	25	39	27
6LXLGWD32	30	45	32

C **GLOBE WHITE-SILVER**

ART. CODE			
6LXLGWS27	25	39	27
6LXLGWS32	30	45	32

B **PARTNER WHITE-GOLD**

ART. CODE			
6LXLGWG07	28	35	75
6LXLGWG09	32	36	91
6LXLGWG12	32	40	115

D **PARTNER WHITE-SILVER**

ART. CODE			
6LXLGWS07	28	35	75
6LXLGWS09	32	36	91
6LXLGWS12	32	40	115





Photo: Luxe Lite Glossy Sea Partner White + Luxe Lite Glossy Breaker Partner White

LUXE LITE COLLECTION



A



B



LUXE LITE GLOSSY BREAKER

A PARTNER WHITE

ART. CODE	⊙	⊘	⊔
6LXLGBW06	28	36	60
6LXLGBW08	31	37	81

LUXE LITE GLOSSY SEA

B PARTNER WHITE

ART. CODE	⊙	⊘	⊔
6LXLGSW06	28	33	60
6LXLGSW08	28	35	75
6LXLGSW09	30	37	91





METALLIC COLLECTION

NL De Metallic-collectie heeft een chique en elegante uitstraling. De handgemaakte plantenbakken zijn volledig bedekt met bladzilver en vervolgens afgewerkt met een laklaag. Deze plantenbakken worden geleverd inclusief een bijpassende waterdichte binnenbak, óf zijn volledig waterdicht.

DE Die Metallic-Kollektion besitzt eine schicke und elegante Ausstrahlung. Diese handgefertigten Pflanzenbehälter sind ganz mit Blattsilber belegt und mit einer Lackschicht überzogen. Sie werden entweder mit einer dazu passenden, wasserdichten Einsatz geliefert oder sind vollständig wasserdicht ausgeführt.

EN The Metallic collection has an elegant and refined look. These handmade planters are completely covered with silver leaf and finished with a layer of lacquer. Each model comes with a matching waterproof liner, or is completely waterproof itself.

FR La collection Metallic offre un look chic et élégant. Les bacs à plantes faits à la main sont complètement recouverts de feuille d'argent, puis finis avec une couche de laque. Ces bacs à plantes sont livrés avec une pochette étanche assorti ou ils sont déjà étanches à la base.



Photo: Metallic Silver leaf Globe Elevated Matt Coffee



Photo: Metallic Silver leaf Globe Elevated Matt Coffee + Metallic Silver leaf Partner Matt Coffee

METALLIC COLLECTION



METALLIC SILVER LEAF

(A) BOAT MATT COFFEE

ART. CODE	↔	↗	☒
6MTLB56CB	56	23	20
6MTLB75CB	75	30	25

(B) BOWL MATT COFFEE

ART. CODE	☒	☒	☒
6MTLC45CB	35	45	27

(C) BOWL UFO MATT COFFEE

ART. CODE	☒	☒	☒
6MTLCU5CB	28	40	15

(D) COUPLE MATT COFFEE

ART. CODE	☒	☒	☒
6MTLD50CB	33	50	45
6MTLD60CB	41	60	55

(E) GLOBE ELEVATED MATT COFFEE

ART. CODE	☒	☒	☒
6MTLC34CB	24	34	31
6MTLC48CB	33	48	45

(F) GLOBE MATT COFFEE

ART. CODE	☒	☒	☒
6MTLC50CB	33	50	37
6MTLC60CB	41	60	43

(G) PARTNER MATT COFFEE

ART. CODE	☒	☒	☒
6MTLP39CB	33	40	75
6MTLP34CB	27	34	90
6MTLP40CB	33	40	90
6MTLP49CB	41	49	90





Photo: Metallic Silver leaf Couple Matt Copper

METALLIC COLLECTION



METALLIC SILVER LEAF

(A) BOAT MATT COPPER

ART. CODE	↔	↗	↓
6MTLB56CR	56	23	20
6MTLB75CR	75	30	25

(B) BOWL MATT COPPER

ART. CODE	☉	☉	↓
6MTLC45CR	35	45	27

(C) BOWL UFO MATT COPPER

ART. CODE	☉	☉	↓
6MTLCU5CR	28	40	15

(D) COUPLE MATT COPPER

ART. CODE	☉	☉	↓
6MTLD50CR	33	50	45
6MTLD60CR	41	60	55

(E) GLOBE MATT COPPER

ART. CODE	☉	☉	↓
6MTLC50CR	33	50	37
6MTLC60CR	41	60	43

(F) PARTNER MATT COPPER

ART. CODE	☉	☉	↓
6MTLP39CR	33	40	75
6MTLP34CR	27	34	90
6MTLP40CR	33	40	90
6MTLP49CR	41	49	90





Photo: Metallic Silver leaf Boat Matt Honey

METALLIC COLLECTION



METALLIC SILVER LEAF

(A) BOAT MATT HONEY

ART. CODE	↔	↗	🗑️
6MTLB56HB	56	23	20
6MTLB75HB	75	30	25

(B) BOWL MATT HONEY

ART. CODE	🌀	🌀	🗑️
6MTLC45HB	35	45	27

(C) BOWL UFO MATT HONEY

ART. CODE	🌀	🌀	🗑️
6MTLCU5HB	28	40	15

(D) COUPLE MATT HONEY

ART. CODE	🌀	🌀	🗑️
6MTLD50HB	33	50	45
6MTLD60HB	41	60	55

(E) GLOBE MATT HONEY

ART. CODE	🌀	🌀	🗑️
6MTLC50HB	33	50	37
6MTLC60HB	41	60	43

(F) PARTNER MATT HONEY

ART. CODE	🌀	🌀	🗑️
6MTLP39HB	33	40	75
6MTLP34HB	27	34	90
6MTLP40HB	33	40	90
6MTLP49HB	41	49	90





Photo: Metallic Silver leaf Partner Matt Ice Blue

METALLIC COLLECTION

METALLIC SILVER LEAF

A PARTNER MATT ICE BLUE

ART. CODE	⊙	⊗	☐
6MTLP39IB	33	40	75
6MTLP34IB	27	34	90
6MTLP40IB	33	40	90
6MTLP49IB	41	49	90

B COUPLE MATT ICE BLUE

ART. CODE	⊙	⊗	☐
6MTLD50IB	33	50	45
6MTLD60IB	41	60	55



C GLOBE ELEVATED MATT SILVER BLUE

ART. CODE	⊙	⊗	☐
6MTLC34SB	24	34	31
6MTLC48SB	33	48	45



D PARTNER MATT LIGHT CHAMPAGNE

ART. CODE	⊙	⊗	☐
6MTLP39LC	33	40	75
6MTLP34LC	27	34	90
6MTLP40LC	33	40	90
6MTLP49LC	41	49	90



E COUPLE MATT LIGHT CHAMPAGNE

ART. CODE	⊙	⊗	☐
6MTLD50LC	33	50	45
6MTLD60LC	41	60	55





Photo: Metallic Silver Leaf Partner Glossy Gold

METALLIC COLLECTION



METALLIC SILVER LEAF

A PARTNER GLOSSY GOLD			
ART. CODE			
6MTLPG090	33	46	90
6MTLPG120	33	46	120

B PARTNER GLOSSY SILVER			
ART. CODE			
6MTLPS090	33	46	90
6MTLPS120	33	46	120



SMART SERIES



COLLECTIONS

BASIC

ECOLINE

TIMELESS

LINE-UP

NL De Smart-serie kenmerkt zich door een eenvoudig design dat kan worden toegepast in elk interieur. De plantenbakken onderscheiden zich door middel van slimme accessoires of stijlvolle accenten.

DE Die Serie Smart kennzeichnet sich durch schlichtes Design das in jeder Einrichtung gut zu ihrem Recht kommen. Die Pflanzgefäße zeichnen sich durch praktischem Zubehör oder stilvollen Akzenten.

EN The Smart series is characterised by a simple design that can be used in any interior. The planters distinguish themselves through smart accessories or stylish accents.

FR La série Smart se caractérise par un design simple qui sont appropriés pour tous les intérieurs. Les bacs à plantes se distinguent par d'accessoires judicieux ou d'éléments élégants.





LET'S CREATE



BASIC COLLECTION

NL De Basic-collectie kenmerkt zich door eenvoud. De basisvormen en kleuren zorgen voor een tijdloos design, waardoor deze plantenbakken geschikt zijn voor elk interieur. Deze plantenbakken zijn gemaakt van Fiberclay, een mengsel van klei en glasvezel. Dit materiaal verkleurt niet en is uv-bestendig. De plantenbakken worden geleverd inclusief een bijpassende waterdichte binnenbak, óf zijn volledig waterdicht.

DE Merkmal der Basic-Kollektion ist die Schlichtheit der Ausführung. Aus den Basisformen und -farben ergibt sich ein zeitloses Design, wodurch diese Pflanzgefäße für jedes Interieur geeignet sind. Als Material wird Fiberclay verwendet, eine Mischung aus Ton und Glasfasern. Dieses Material ist lichtecht und UV-beständig. Die Pflanzgefäße werden entweder mit einer dazu passenden, wasserdichten Einsatz geliefert oder sind vollständig wasserdicht ausgeführt.

EN The Basic collection is characterised by its simplicity. The basic shapes and colours create timeless designs, making these planters suitable for any interior. The Basic models are made of fibreclay, a mixture of fibreglass and clay. This material does not discolour and is UV resistant. Basic planters come with a matching waterproof liner, or are completely waterproof themselves.

FR La collection Basic se caractérise par sa simplicité. Les formes et les couleurs de base offrent un design intemporel, ce qui fait que ces pots s'adaptent à tous les intérieurs. Ces bacs à plantes sont fabriqués à partir de Fiberclay, un mélange d'argile et de fibre de verre. Ce matériau ne décolore pas et est résistant aux rayons UV. Ces bacs à plantes sont livrés avec une pochette étanche assorti ou ils sont déjà étanches à la base.



Photo: Basic Rectangle Dark Grey + Basic Cylinder Dark Grey

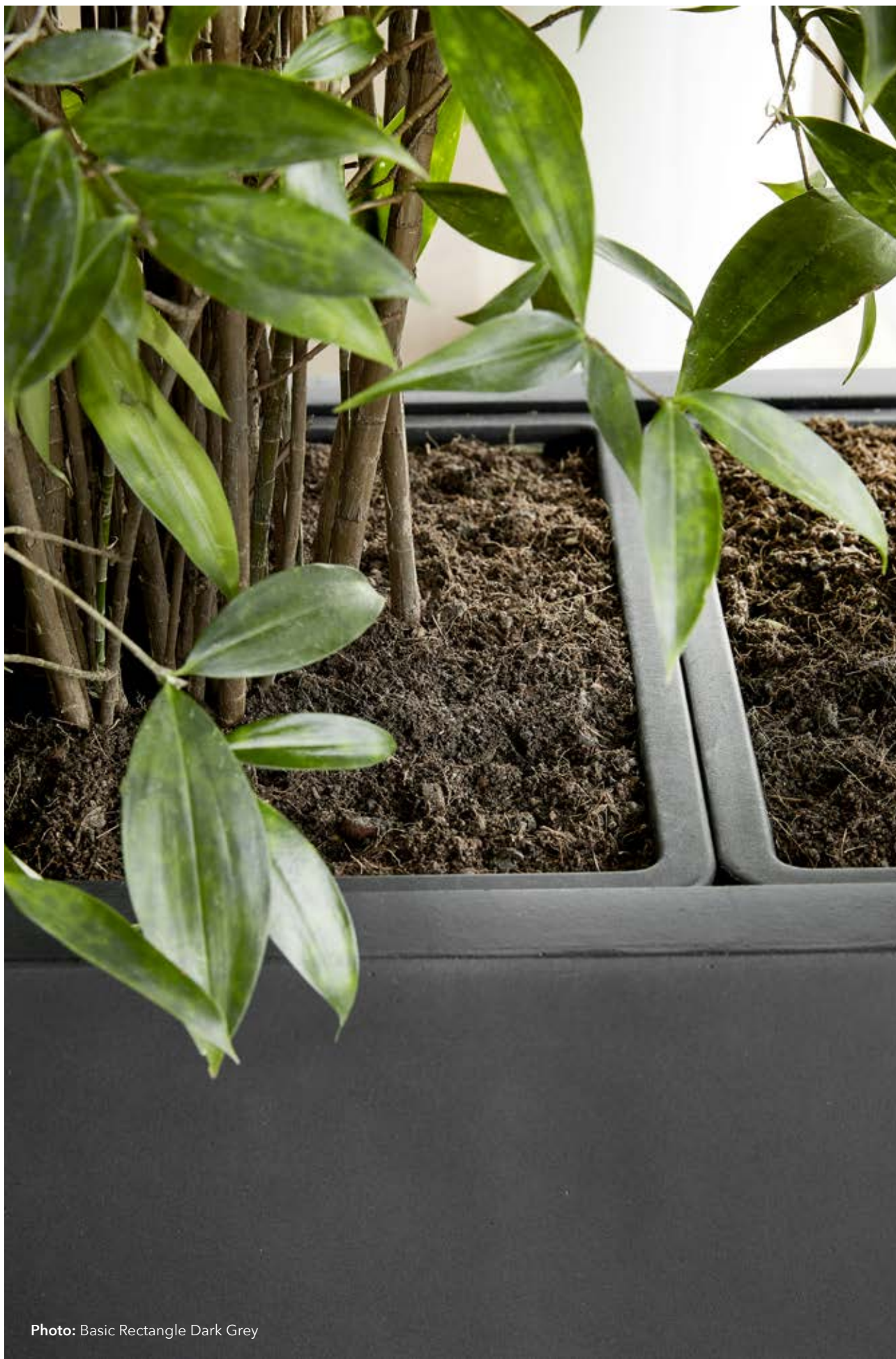

Photo: Basic Rectangle Dark Grey

BASIC COLLECTION



A CYLINDER DARK GREY

ART. CODE	⊙	⊘	∩
6BSCC613P	24	30	55
6BSCC614P	33	40	68

B RECTANGLE DARK GREY

ART. CODE	↔	↗	∩
6BSCR615P	110	40	40
6BSCR616P	110	40	70

C SQUARE DARK GREY

ART. CODE	↔	↗	∩
6BSCS610P	15	15	26
6BSCS611P	31	31	56
6BSCS612P	38	38	68



D CUBE DARK GREY

ART. CODE	↔	↗	∩
6BSCC609P	15	15	20





ECOLINE COLLECTION

NL Ecoline plantenbakken zijn gemaakt van gerecycled kunststof. De materialen zijn afkomstig van producten die al een zinvol leven achter de rug hebben, zoals oude autobumpers, telefoons, keyboards, computers en stofzuigers. Deze producten worden versnipperd, verhit en daarna in een nieuwe vorm gegoten. Op deze manier krijgen oude gebruikte producten een tweede leven. De plantenbakken worden in alle RAL-kleuren* geleverd en zijn verkrijgbaar met handige accessoires.
* *Met uitzondering van de parelmoer- en fluorkleuren.*

DE Die Ecoline-Pflanzgefäße werden aus Recyclingkunststoff hergestellt. Das Material stammt von Produkten, die bereits eine nützliche Verwendung hinter sich haben, beispielsweise von alten Stoßstangen, Telefonen, Tastaturen, Computern und Staubsaugern. Diese Produkte werden geschreddert, erhitzt und in neue Formen gegossen. So erhalten Altprodukte ein zweites Leben. Die Pflanzgefäße sind in allen RAL-Farben* und mit praktischen Zubehör lieferbar.
* *Mit Ausnahme der Perlmutt- und Fluorfarben.*

EN Ecoline planters are made from recycled plastic. The materials originate from products that have already served their purpose in life, such as old car bumpers, phones, keyboards, computers and vacuum cleaners. These products are shredded, heated and moulded into a new shape. This gives used products a second life. The planters are available in all RAL colours* and with handy accessories.
* *With the exception of the mother-of-pearl and fluor colours.*

FR Les bacs à plantes Ecoline sont fabriqués en plastique recyclé. Les matériaux proviennent de produits recyclés à la fin de leur vie utile, comme des vieux pare-chocs, téléphones, claviers, ordinateurs et aspirateurs. Ces produits sont déchiquetés, fondus et le plastique obtenu est ensuite moulé pour confectionner de nouveaux produits. Ainsi, de vieux produits usagés vont commencer une deuxième vie. Les bacs à plantes sont fournis dans toutes les couleurs RAL* et sont disponibles avec des accessoires pratiques.
* *À l'exception des couleurs nacrées et fluor.*



Photo: Ecoline Rise Regular Partner Straight



Photo: Ecoline Rise Regular Rectangle

ECOLINE COLLECTION



ECOLINE RISE REGULAR

A COUPLE STRAIGHT

ART. CODE	☉	☒	☒	WHEELPLATE	LINER HYDRO
6ECOC4042	39	40	40	6ECOAR015	6ECOAR008
6ECOC5054	49	50	50	6ECOAR014	6ECOAR009

B CUBE

ART. CODE	↔	↙	☒	WHEELPLATE	LINER HYDRO
6ECOC2224	22	22	22		
6ECOC4142	41	41	40	6ECOAR018	6ECOAR005
6ECOC5052	50	50	50	6ECOAR016	6ECOAR006

C KUBIS

ART. CODE	↔	↙	☒	WHEELPLATE	LINER SOIL	LINER HYDRO	IRRIGATION SYSTEM
6ECON3672	36	36	70	6ECOAR017		6ECOAR002	
6ECON4177	41	41	75	6ECOAR018	6ECOAR012	6ECOAR003	6ECOAP015

D PARTNER STRAIGHT

ART. CODE	☉	☒	☒	WHEELPLATE	LINER SOIL	LINER HYDRO	IRRIGATION SYSTEM
6ECON4077	39	40	75	6ECOAR015	6ECOAR010	6ECOAR001	6ECOAP017

E RECTANGLE

ART. CODE	↔	↙	☒	WHEELPLATE	LINER HYDRO
6ECON6020	60	18	16		
6ECON8023	80	20	23		
6ECON9042	90	40	60	6ECOAR013	6ECOAR007





Photo: Ecoline Rise Structure Kubis

ECOLINE COLLECTION



(B)



(A)

ECOLINE RISE STRUCTURE

(A) RECTANGLE

ART. CODE	↔	↙	⏏	WHEELPLATE	LINER HYDRO
6ECOR6018	60	18	16		
6ECOR8020	80	20	23		
6ECOR9040	90	40	60	6ECOAR013	6ECOAR007

(B) KUBIS

ART. CODE	↔	↙	⏏	WHEELPLATE	LINER SOIL	LINER HYDRO	IRRIGATION SYSTEM
6ECOK4175	41	41	75	6ECOAR018	6ECOAR012	6ECOAR003	6ECOAP015

(C) PARTNER STRAIGHT

ART. CODE	⊙	⊘	⏏	WHEELPLATE	LINER SOIL	LINER HYDRO	IRRIGATION SYSTEM
6ECP4075	39	40	75	6ECOAR015	6ECOAR010	6ECOAR001	6ECOAP017



(C)





ECOLINE
RISE ACCESSORIES

A LINER HYDRO ROUND
ART. CODE **MATCHING PLANTER**
 6ECOAR001 36 39 69 6ECOC4342 6ECOP4075 6ECOP4077

B 6ECOAR008 36 39 34 6ECOC4042
 6ECOAR009 45 49 44 6ECOC5054

C LINER HYDRO SQUARE
ART. CODE **MATCHING PLANTER**
 6ECOAR002 34 34 64 6ECOK3672
 6ECOAR003 40 40 69 6ECOK4176 6ECOK4177 6ECOK4175
 6ECOAR005 40 40 34 6ECOC4142
 6ECOAR006 49 49 44 6ECOC5052

D LINER HYDRO RECTANGLE
ART. CODE **MATCHING PLANTER**
 6ECOAR007 89 39 54 6ECOR9040 6ECOR9042

E LINER SOIL ROUND
ART. CODE **MATCHING PLANTER**
 6ECOAR010 36 39 70 6ECOP4077 6ECOP4075

F LINER SOIL SQUARE
ART. CODE **MATCHING PLANTER**
 6ECOAR012 40 40 70 6ECOK4177 6ECOK4175 6ECOK4176



ECOLINE COLLECTION

G



H



I



G

WHEELPLATE RECTANGLE

ART. CODE	←	↗	🗑️	MATCHING PLANTER
6ECOAR013	78	28	5	6ECOR9040 6ECOR9042

H

WHEELPLATE ROUND

ART. CODE	⊘	🗑️	MATCHING PLANTER
6ECOAR015	29	2	6ECOC4042 6ECOP4075 6ECOP4077
6ECOAR014	38	5	6ECOC5054

I

WHEELPLATE SQUARE

ART. CODE	←	↗	🗑️	MATCHING PLANTER
6ECOAR017	24	24	5	6ECOK3672
6ECOAR018	29	29	5	6ECOC4142 6ECOK4175 6ECOK4177
6ECOAR016	38	38	5	6ECOC5052





Photo: Ecoline Phoenix Regular Partner Straight

ECOLINE COLLECTION

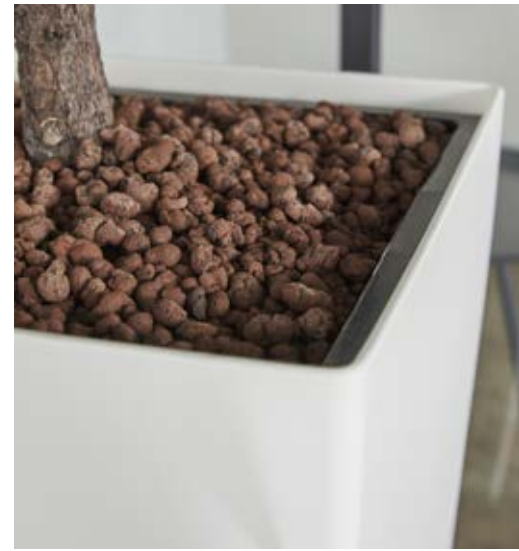
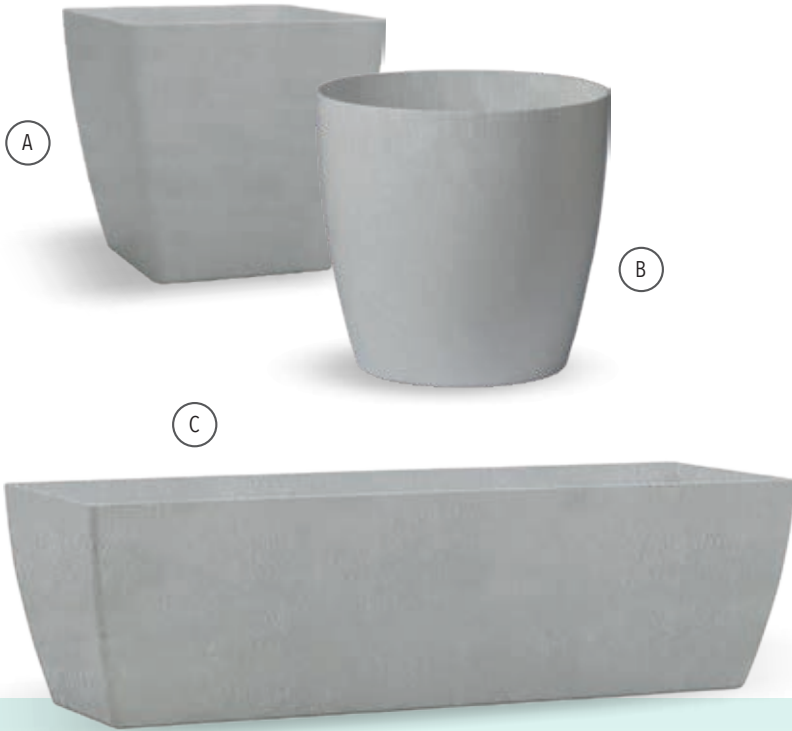

ECOLINE PHOENIX REGULAR

A CUBE

ART. CODE	↔	/	∩
6ECOC1817	18	18	17
6ECOC2524	25	25	24
6ECOC3231	32	32	31
6ECOC4343	43	43	42
6ECOC5252	52	52	50

B COUPLE

ART. CODE	⊙	⊘	∩	WHEELPLATE	LINER HYDRO
6ECOC2017	19	20	17		
6ECOC2825	27	28	25		
6ECOC3328	32	33	28		
6ECOC3833	37	38	33		
6ECOC4342	42	43	42	6ECOAP001	6ECOAR001
6ECOC5250	50	52	50	6ECOAP002	

C RECTANGLE

ART. CODE	↔	/	∩
6ECOR6218	60	20	18

D KUBIS

ART. CODE	↔	/	∩	WHEELPLATE	LINER SOIL	LINER HYDRO	IRRIGATION SYSTEM	POLYSTYRENE BASE
6ECON3056	30	30	56		6ECOAP003			6ECOAP019
6ECON4176	41	41	76	6ECOAP020	6ECOAR012	6ECOAR003	6ECOAP015	
6ECON4991	49	49	91		6ECOAP004		6ECOAP015	

E PARTNER STRAIGHT

ART. CODE	⊙	⊘	∩	LINER SOIL	LINER HYDRO	IRRIGATION SYSTEM	POLYSTYRENE BASE
6ECOP3366	32	33	66	6ECOAP005			6ECOAP018
6ECOP4176	39	41	76	6ECOAP006	6ECOAP007	6ECOAP017	
6ECOP4191	39	41	91	6ECOAP008	6ECOAP009	6ECOAP017	





ECOLINE
PHOENIX ACCESSORIES

A IRRIGATION SYSTEM ROUND
ART. CODE **MATCHING PLANTER**
 6ECOAP017 33 10 6ECOP4075 6ECOP4077 6ECOP4176 6ECOP4191

B IRRIGATION SYSTEM SQUARE
ART. CODE **MATCHING PLANTER**
 6ECOAP015 33 33 10 6ECOK4175 6ECOK4177 6ECOK4176 6ECOK4991

C LINER HYDRO ROUND
ART. CODE **MATCHING PLANTER**
 6ECOAP007 36 39 74 6ECOP4176
 6ECOAP009 36 39 90 6ECOP4191

D LINER SOIL ROUND
ART. CODE **MATCHING PLANTER**
 6ECOAP005 28 32 65 6ECOP3366
 6ECOAP006 36 39 75 6ECOP4176
 6ECOAP008 36 39 90 6ECOP4191

E LINER SOIL SQUARE
ART. CODE **MATCHING PLANTER**
 6ECOAP003 29 29 55 6ECOK3056
 6ECOAP004 47 47 89 6ECOK4991

ECOLINE COLLECTION

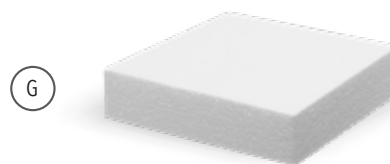

F POLYSTYRENE BASE ROUND
 ART. CODE ∅ H MATCHING PLANTER
 6ECOAP018 25 10 6ECOP3366

H WHEELPLATE ROUND
 ART. CODE ∅ H MATCHING PLANTER
 6ECOAP001 27 5 6ECOC4342
 6ECOAP002 31 5 6ECOC5250

G POLYSTYRENE BASE SQUARE
 ART. CODE ↔ ↗ H MATCHING PLANTER
 6ECOAP019 22 22 6 6ECOK3056

I WHEELPLATE SQUARE
 ART. CODE ↔ ↗ H MATCHING PLANTER
 6ECOAP020 26 26 5 6ECOK4176



TIMELESS COLLECTION

NL De Timeless-collectie staat altijd en overal op zijn plek! Dankzij de strakke vormgeving zijn de plantenbakken geschikt voor elk type interieur. Bovendien zijn de plantenbakken verkrijgbaar in alle RAL-kleuren*, waardoor je deze perfect kunt combineren met andere kleuren in het interieur. De Timeless collectie is verkrijgbaar met een aantal handige accessoires die het assembleren van de plantenbakken gemakkelijker maken.

** Met uitzondering van de parelmoer- en fluorkleuren.*

DE Die Timeless-Kollektion macht immer und überall eine gute Figur! Dank ihres schlichten Designs harmonisieren diese Pflanzgefäße mit jeder Einrichtung. Außerdem sind sie in allen RAL-Farben* lieferbar, wodurch sie sich ausgezeichnet mit anderen Einrichtungsfarben kombinieren lassen. Zur Timeless-Kollektion sind verschiedene praktische Zubehör erhältlich, die die Montage der Pflanzgefäße erleichtern.

** Mit Ausnahme der Perlmutt- und Fluorfarben.*

EN The Timeless collection looks great anytime and everywhere! Thanks to the sleek design, the planters suit any type of interior. Moreover, they are available in any RAL colour*, so that you can combine them perfectly with other colours in the interior. The Timeless collection is available with several handy accessories that make it easier to assemble the planters.

** With the exception of the mother-of-pearl and fluor colours.*

FR La collection Timeless propose une gamme de produits qui trouvent toujours une place dans un intérieur ! Grâce à leur design élégant, les bacs à plantes conviennent à chaque type d'intérieur. En outre, les bacs à plantes sont disponibles dans toutes les couleurs RAL*, si bien que tu peux les combiner aux couleurs de votre intérieur. La collection Timeless a aussi des accessoires pratiques qui facilitent l'assemblage des bacs à plantes.

** À l'exception des couleurs nacrées et fluor.*

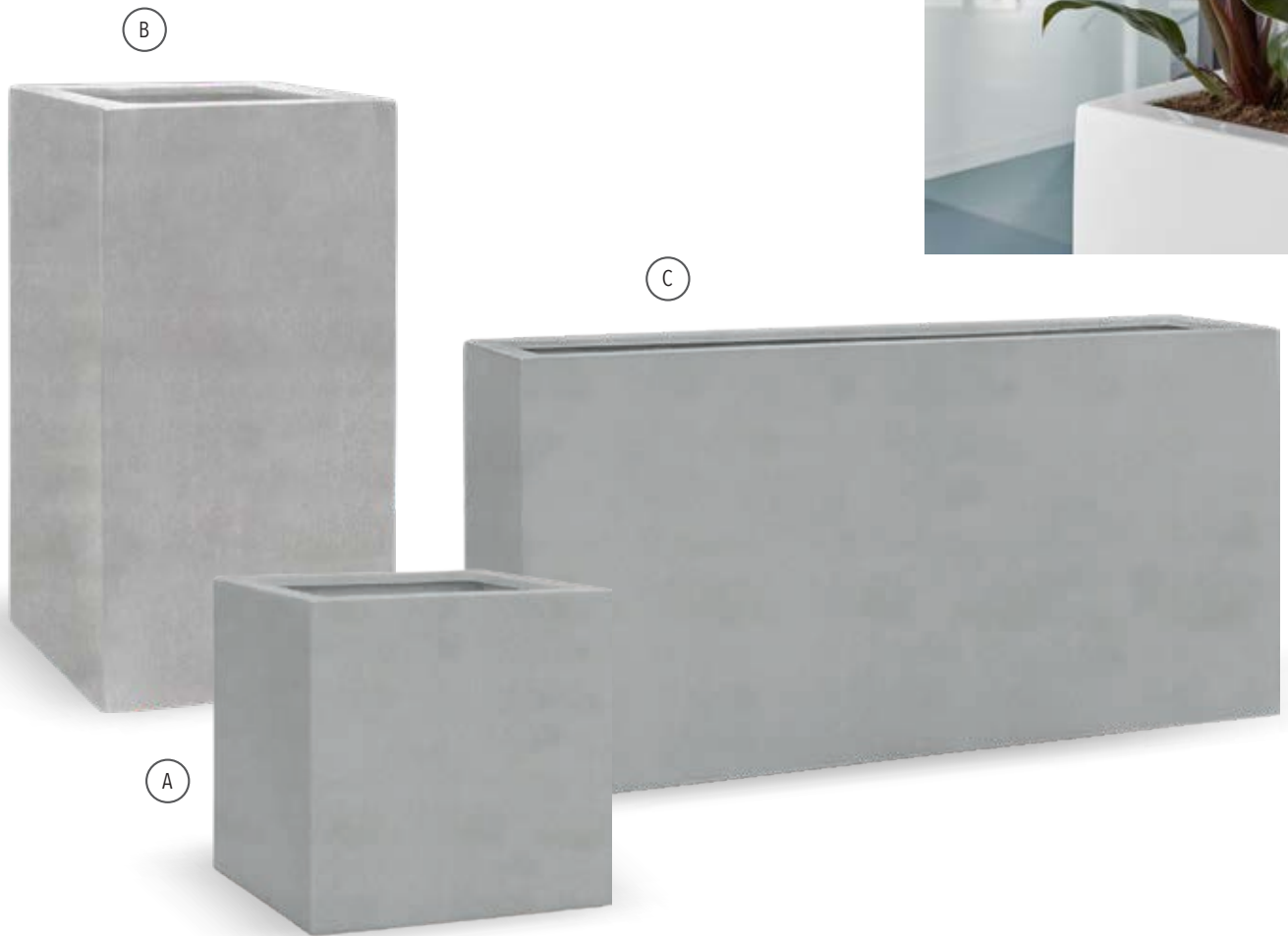

Photo: Timeless Ovation Regular Emperor



Photo: Timeless Largo Regular Rectangle

TIMELESS COLLECTION



TIMELESS LARGO REGULAR

A CUBE							
ART. CODE	↔	/	∩	WHEELPLATE			
6TIMC2121	21	21	21				
6TIMC4040	40	40	40	6TIMAL005			

B SQUARE							
ART. CODE	↔	/	∩	WHEELPLATE	INSERT PLATE		
6TIMS4022	40	40	22				
6TIMS4075	40	40	75	6TIMAL005	6TIMAL001		
6TIMS4010	40	40	100	6TIMAL005	6TIMAL001		

C RECTANGLE							
ART. CODE	↔	/	∩	WHEELPLATE	LINER	INSERT PLATE	
6TIMR6018	60	20	18				
6TIMR8022	80	40	22	6TIMAL007			
6TIMR1022	100	40	22				
6TIMR8040	80	40	40	6TIMAL007	6TIMAL014		
6TIMR1240	120	40	40	6TIMAL008	6TIMAL013		
6TIMR8075	80	40	75	6TIMAL007	6TIMAL014	6TIMAL002	
6TIMR1275	120	40	75	6TIMAL008	6TIMAL013	6TIMAL003	
6TIMR1575	150	40	75			6TIMAL004	





Photo: Timeless Largo Wheelplate Rectangle

TIMELESS COLLECTION

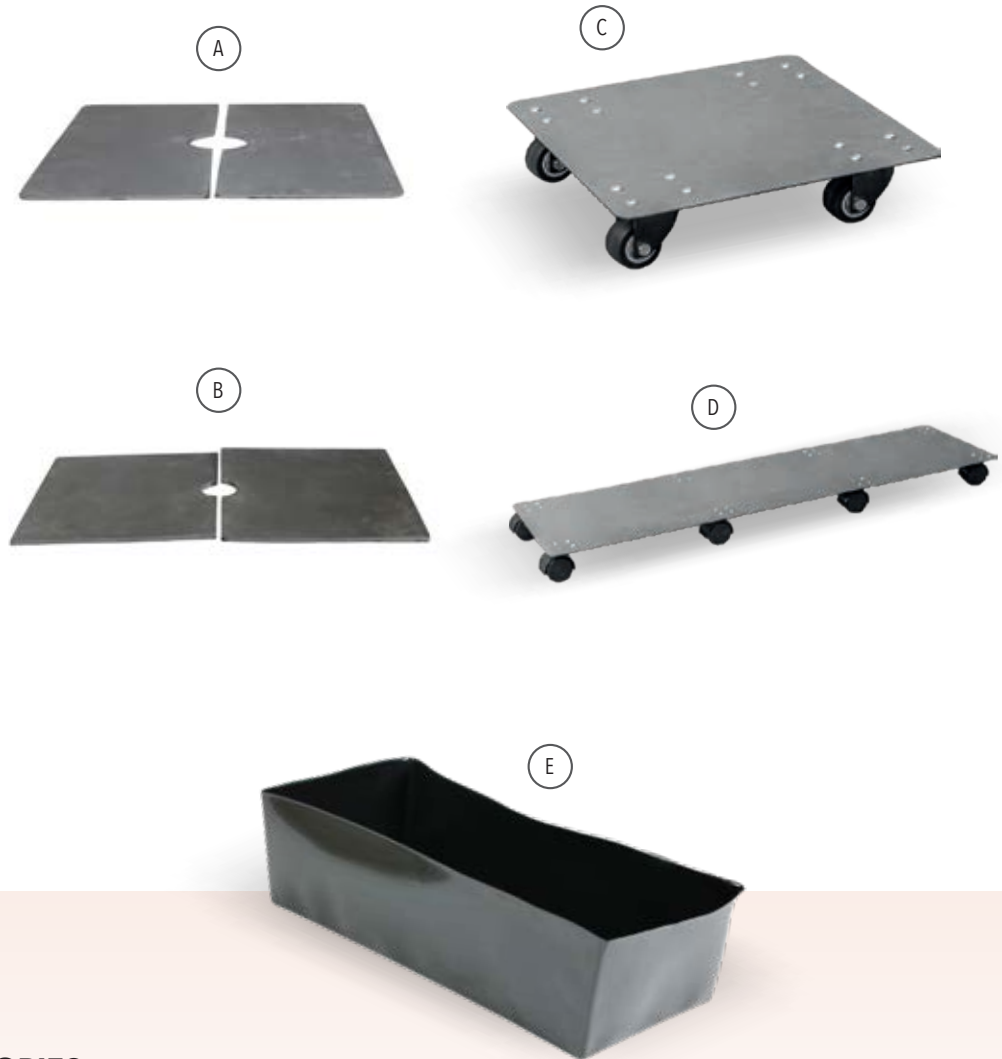

TIMELESS LARGO ACCESSORIES

A INSERT PLATE (2 PARTS) SQUARE

ART. CODE	↔	↙	📏	MATCHING PLANTER
6TIMAL001	39	20	1	6TIMS4075 6TIMS4010

B INSERT PLATE (2 PARTS) RECTANGLE

ART. CODE	↔	↙	📏	MATCHING PLANTER
6TIMAL002	39	37	1	6TMR8075
6TIMAL003	59	37	1	6TMR1275
6TIMAL004	74	37	1	6TMR1275

C WHEELPLATE SQUARE

ART. CODE	↔	↙	📏	MATCHING PLANTER
6TIMAL005	28	28	6	6TIMS4010 6TMC4040 6TIMS4075
6TIMAL006	37	37	7	6TMC5050

D WHEELPLATE RECTANGLE

ART. CODE	↔	↙	📏	MATCHING PLANTER
6TIMAL007	67	27	7	6TMR8075 6TMR8040 6TMR8022
6TIMAL008	107	27	7	6TMR1275 6TMR1240

E LINER RECTANGLE

ART. CODE	↔	↙	📏	MATCHING PLANTER
6TIMAL014	80	40	40	6TMR8040 6TMR8075
6TIMAL013	120	40	40	6TMR1240 6TMR1275



Photo: Timeless Ovation Regular Vulcan

TIMELESS COLLECTION



TIMELESS OVATION REGULAR

A	OVAL	ART. CODE	↔	/	∩
		6TIMO3417	34	22	17
		6TIMO5025	50	32	25

C	VULCAN	ART. CODE	↔	/	∩
		6TIMV6550	65	56	50
		6TIMV9775	98	84	75
		6TIMV1185	110	95	85

B	PURE VASE	ART. CODE	↔	/	∩
		6TIME5094	50	32	94

TIMELESS SOLO REGULAR

D	RECTANGLE	ART. CODE	↔	/	∩	WHEELPLATE	POLYSTYRENE BASE
		6TMR8043	80	30	43	6TIMAS001	6TIMAS002



TIMELESS SOLO ACCESSORIES

E	WHEELPLATE RECTANGLE	ART. CODE	↔	/	∩	MATCHING PLANTER
		6TIMAS001	68	22	6	6TMR8043

F	POLYSTYRENE BASE RECTANGLE	ART. CODE	↔	/	∩	MATCHING PLANTER
		6TIMAS002	75	25	13	6TMR8043



Photo: Timeless Sphere Regular Globe

TIMELESS COLLECTION

A



B



C



D



TIMELESS SPHERE REGULAR

A

GLOBE

ART. CODE	☉	☉	☐
6TIMG5748	30	57	48
6TIMG7865	40	78	65

TIMELESS CONO REGULAR

B

PARTNER STRAIGHT

ART. CODE	☉	☉	☐	INSERT PLATE HYDRO
6TIMP4375	33	43	75	6TIMAC001



TIMELESS CONO ACCESSORIES

C

INSERT PLATE HYDRO ROUND

ART. CODE	☉	☐	MATCHING PLANTER
6TIMAC001	39	1	6TIMP4375



LINE-UP COLLECTION

NL De Line-Up-collectie is voorzien van subtiele lijnen die de plantenbakken een stijlvolle uitstraling geven. De plantenbakken zijn gemaakt van PVC foam, een hoogwaardig kunststof dat bijzonder licht van gewicht maar wel sterk is. Na gebruik is het materiaal gemakkelijk te recyclen. Deze plantenbakken worden geleverd inclusief een bijpassende waterdichte binnenbak. Na het boren van een gat in de bodem, is de Line-Up ook geschikt voor buiten.

DE Die Line-Up-Kollektion zeichnet sich durch ein feines Liniendekor aus, das für eine stilvolle Ausstrahlung der Pflanzgefäße sorgt. Sie sind aus PVC-Hartschaum gefertigt, einem hochwertigen Kunststoffmaterial von geringem Gewicht, das dennoch sehr robust ist und sich ohne Probleme wiederverwenden lässt. Im Lieferumfang enthalten ist eine passende, wasserdichte Einsatz. Wird ein Loch in den Boden gebohrt, so eignen sich die Line-up-Pflanzgefäße auch für die Aufstellung im Freien.

EN The Line-Up collection features subtle lines that give it a stylish look. The planters are made of PVC foam, a high-quality, easy-to-recycle plastic that is both lightweight and durable. Each Line-up model comes with a matching waterproof liner. By drilling a hole in the bottom, the Line-up can easily be made suitable for outdoor use.

FR La collection Line-Up présente des lignes subtiles qui donnent un look élégant aux bacs à plantes. Les bacs à plantes sont fabriqués à partir de mousse de PVC, une matière plastique haute qualité qui est particulièrement légère et solide à la fois. Après utilisation, le matériau est facile à recycler. Ces bacs de plantes sont livrés avec une pochette étanche assorti. Le Line-up peut également être utilisé à l'extérieur, il suffit de percer un trou dans le fond.



Photo: Line-Up Rectangle Matt Black



Photo: Line-Up Rectangle Matt Black

LINE-UP COLLECTION



(A)



(B)



(C)



(A)

RECTANGLE MATT BLACK

ART. CODE	↔	/	⊥	
6LUPR18MB	110	38	75	WHEELPLATE INCLUDED
6LUPR60MB	74	38	75	WHEELPLATE INCLUDED
6LUPR88MB	88	30	75	

(C)

CUBE MATT BLACK

ART. CODE	↔	/	⊥	
6LUPC48BW	48	48	48	WHEELPLATE INCLUDED

(B)

SQUARE MATT BLACK

ART. CODE	↔	/	⊥	
6LUP375MB	30	30	75	
6LUP376MB	38	38	75	WHEELPLATE INCLUDED





Photo: Line-Up Rectangle Matt White

LINE-UP COLLECTION



(A)



(B)



(C)



(A) RECTANGLE MATT WHITE

ART. CODE	↔	/	∩	
6LUPR18MW	110	38	75	WHEELPLATE INCLUDED
6LUPR60MW	74	38	75	WHEELPLATE INCLUDED
6LUPR88MW	88	30	75	

(B) SQUARE MATT WHITE

ART. CODE	↔	/	∩	
6LUP375MW	30	30	75	
6LUP376MW	38	38	75	WHEELPLATE INCLUDED

(C) CUBE MATT WHITE

ART. CODE	↔	/	∩	
6LUPC48WW	48	48	48	WHEELPLATE INCLUDED



SOLID SERIES



COLLECTIONS

POLYSTONE
POLYSTONE COATED
TERRAZZO
NUCAST®
NATURESCAST®
RAINDROP
VERTICAL RIB

NL De Solid-serie kenmerkt zich door een stoer en robuust karakter. Deze plantenbakken vormen een krachtig en stijlvol accent in het interieur.

DE Die Serie Solid kennzeichnet sich durch einen rustikalen, robusten Charakter. Die Pflanzgefäße verleihen der Einrichtung wirkungsstarke und stilvolle Akzente.

EN The Solid series has a sturdy and robust character. These planters form a powerful and stylish addition to any interior.

FR La série Solid est caractérisée par son caractère solide et robuste. Ces bacs à plantes apportent un accent puissant et stylé aux intérieurs.





LET'S CREATE

POLYSTONE COLLECTION

NL Deze plantenbakken met authentieke stenen uiterlijk zijn gemaakt van Polystone, een mengsel van kunststof en gemalen kalksteen. Dit materiaal, met dezelfde uiterlijke kenmerken als natuursteen, is verrassend licht van gewicht. Een aantal modellen is voorzien van waterdichte binnenbak.

DE Diese Pflanzgefäße mit einer authentischen Steinoberfläche bestehen aus Polystone, einer Mischung aus Kunststoff und gemahlenem Kalkstein. Das optisch wie Naturstein wirkende Material ist überraschend leicht. Einige Modelle sind mit einem wasserdichten Einsatz ausgeführt.

EN The planters in our Polystone collection get their authentic stone look from polystone, a mixture of plastic and ground limestone. While this material is externally similar to natural stone, it's also surprisingly lightweight. A number of the models come with a waterproof liner.

FR Ces bacs à plantes au look authentique de pierre sont fabriqués à partir de Polystone, un mélange de matière synthétique et de pierre calcaire broyée. Ce matériau, présentant les mêmes caractéristiques physiques que la pierre naturelle, est étonnamment léger. Un certain de nombre de modèles sont équipés d'une pochette étanche.



NL Gebruik een Baq inzethoes om deze plantenbak waterdicht te maken.

DE Verwenden Sie eine Baq-Einsatz, um diesen Pflanzgefäß wasserdicht zu machen.

EN Use a Baq liner to make this planter watertight.

FR Utilisez une pochette de Baq pour rendre cette bac à plantes étanche.

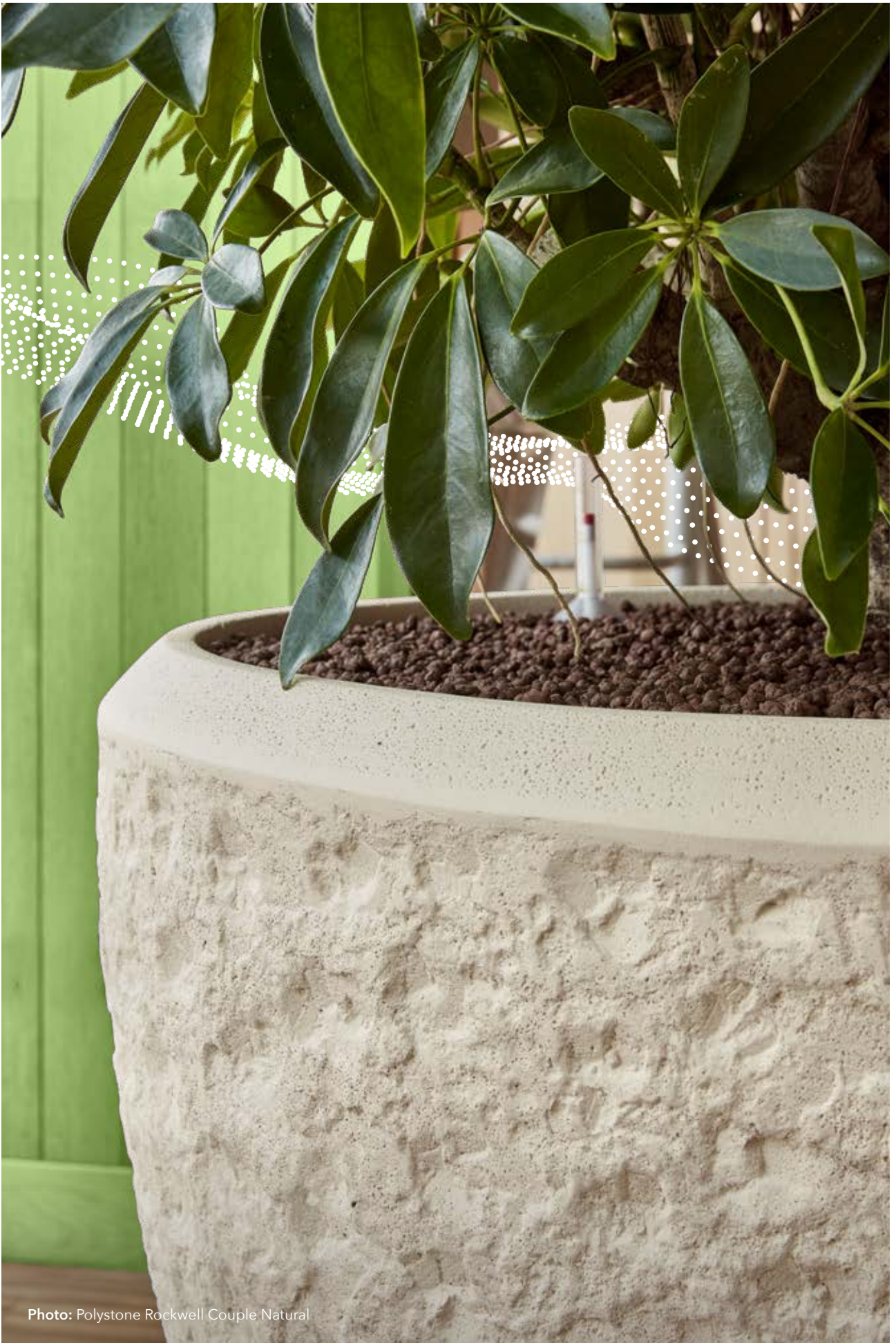

Photo: Polystone Rockwell Couple Natural



Photo: Polystone Plain Partner Natural

POLYSTONE COLLECTION



POLYSTONE PLAIN

A	BOAT NATURAL			
ART. CODE		↔	↙	☐
6POSPB010		46	20	13
6POSPB020		68	33	18

B	BOWL NATURAL			
ART. CODE		☉	☉	☐
6POSXA30		11	17	11

C	COUPLE NATURAL			
ART. CODE		☉	☉	☐
6POSP0007		21	24	24
6POSP0011		30	40	40
6POSP0021		41	50	50
6POSP0030		58	65	65
6POSP0040		71	80	80

D	PARTNER NATURAL			
ART. CODE		☉	☉	☐
6POSP0003		24	30	70
6POSP0005		27	37	90
6POSP0001		39	50	120





Photo: Polystone Plain Boat Grey

POLYSTONE COLLECTION



POLYSTONE PLAIN

A BOAT GREY

ART. CODE	↔	↙	☐
6POSRBL46	46	20	13
6POSRBL68	68	33	18

B BOWL GREY

ART. CODE	☉	☉	☐
6POSXA10	11	17	11

C COUPLE GREY

ART. CODE	☉	☉	☐
6POSP0009	21	24	24
6POSRC40	30	40	40
6POSRC50	41	50	50
6POSRC65	58	65	65
6POSRC80	71	80	80

D PARTNER GREY

ART. CODE	☉	☉	☐
6POSRL30	24	30	70
6POSRL37	27	37	90
6POSRL50	39	50	120





Photo: Polystone Plain Partner Smoke

POLYSTONE COLLECTION



POLYSTONE PLAIN

A	BOAT SMOKE			
	ART. CODE	↔	/	☐
	6POSPBS10	46	20	13
	6POSPBS20	68	33	18

B	BOWL SMOKE			
	ART. CODE	☉	☉	☐
	6POSXA50	11	17	11

C	COUPLE SMOKE			
	ART. CODE	☉	☉	☐
	6POSP0070	20	24	24
	6POSP0091	30	40	40
	6POSP0101	41	50	50
	6POSP0110	57	65	65
6POSP0120	71	80	80	

D	PARTNER SMOKE			
	ART. CODE	☉	☉	☐
	6POSPP016	24	30	70
	6POSPP021	27	37	90
6POSPP031	39	50	120	





Photo: Polystone Plain Couple Rock

POLYSTONE COLLECTION



POLYSTONE PLAIN

(A)	BOAT ROCK			
ART. CODE		↔	/	∩
6POSRB010		46	20	13
6POSRB020		68	33	18

(B)	BOWL ROCK			
ART. CODE		⊙	⊗	∩
6POSXA40		11	17	11

(C)	COUPLE ROCK			
ART. CODE		⊙	⊗	∩
6POSRC24		20	24	24
6POSRC41		30	40	40
6POSRC51		41	50	50
6POSRC65		57	65	65
6POSRC80		71	80	80

(D)	PARTNER ROCK			
ART. CODE		⊙	⊗	∩
6POSRPP31		24	30	70
6POSRPP38		27	37	90
6POSRPP51		39	50	120





Photo: Polystone Rockwell Couple Natural

POLYSTONE COLLECTION

POLYSTONE ROCKWELL

A PARTNER NATURAL

		ART. CODE			
		6POSWPN31	24	30	70
		6POSWPN38	27	37	90

B COUPLE NATURAL



		ART. CODE			
		6POSWCN41	30	40	40
		6POSWCN51	41	50	50
		6POSWCN65	58	65	65

C PARTNER SMOKE

		ART. CODE			
		6POSWPS31	24	30	70
		6POSWPS38	27	37	90



D COUPLE SMOKE

		ART. CODE			
		6POSWCS41	30	40	40
		6POSWCS51	41	50	50
		6POSWCS65	58	65	65

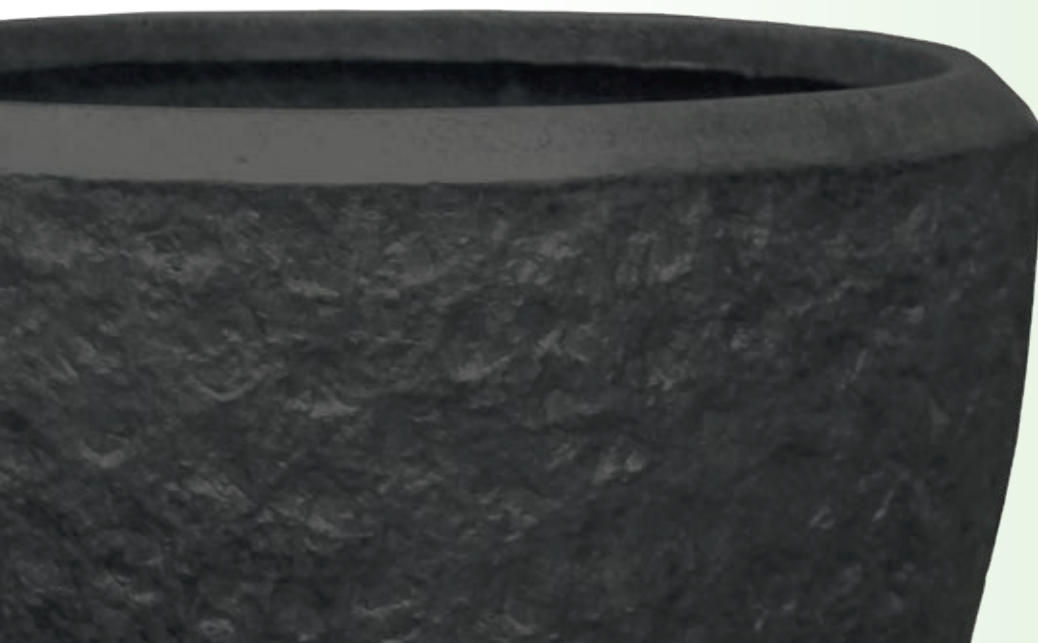



Photo: Polystone Rough Bowl Rock



POLYSTONE COLLECTION

POLYSTONE ROUGH

A COUPLE ROCK

ART. CODE			
6POSRC405	30	40	40
6POSRC506	41	50	50
6POSRD607	39	60	75

B PARTNER ROCK

ART. CODE			
6POSRP308	24	30	70
6POSRP310	27	37	90
6POSRP502	39	50	120



C BOWL ROCK



ART. CODE			
6POSRB063	49	60	30





Photo: Polystone Seaside Partner Natural

POLYSTONE COLLECTION



POLYSTONE SEASIDE

A PARTNER NATURAL

ART. CODE				
6POSPS011	24	30	70	
6POSPS021	27	37	90	
6POSPS031	39	50	120	

B PARTNER SMOKE

ART. CODE				
6POSPS211	24	30	70	
6POSPS221	27	37	90	
6POSPS231	39	50	120	





Photo: Polystone Nathan James Balloon Pueter Champagne

POLYSTONE COLLECTION



POLYSTONE NATHAN JAMES

A BALLOON PUETER CHAMPAGNE

ART. CODE			
6POSYNB60	55	60	63
6POSYNB80	75	80	73

B PARTNER PUETER CHAMPAGNE

ART. CODE			
6POSYNP38	27	37	90
6POSYNP47	39	46	110

C PARTNER WHITE

ART. CODE			
6POSYNN39	27	37	90
6POSYNN47	39	46	110





POLYSTONE COATED COLLECTION

NL De Polystone Coated is een variant van de Polystone-collectie. Deze plantenbakken onderscheiden zich door middel van een speciale coating, waardoor deze geheel waterdicht, waterafstotend en uv-bestendig zijn.

DE Beim Polystone Coated handelt es sich um eine Variante der Polystone-Kollektion. Diese Pflanzgefäße unterscheiden sich durch eine besondere Beschichtung, die dafür sorgt, dass sie vollständig wasserdicht, wasserabweisend und UV-beständig sind.

EN The Polystone Coated is part of the Polystone collection. Thanks to their special coating, they are completely waterproof, water-repellent and UV resistant.

FR Le Polystone Coated est une variante de la collection Polystone. Ces bacs à plantes ont été traités avec un revêtement spécial pour les rendre entièrement étanches, déperlants et résistants aux rayons UV.



Photo: Polystone Coated Darcy Raw Grey



Photo: Polystone Coated Balloon Natural

POLYSTONE COATED COLLECTION



POLYSTONE COATED PLAIN

A BALLOON NATURAL

ART. CODE	Ø	Ø	H
6PSC463NT	27	42	42
6PSC464NT	30	48	55
6PSC465NT	30	52	68

B COPPA NATURAL

ART. CODE	Ø	Ø	H
6PSC469NT	30	45	55
6PSC470NT	30	48	80

C EMPEROR NATURAL

ART. CODE	Ø	Ø	H
6PSC474NT	24	39	90





Photo: Polystone Coated Plain Darcy Raw Grey

POLYSTONE COATED COLLECTION



POLYSTONE COATED PLAIN

A **BALLOON RAW GREY**

ART. CODE	Ø	Ø	∪
6PSC463RG	27	42	42
6PSC464RG	30	48	55
6PSC465RG	30	52	68

B **COPPA RAW GREY**

ART. CODE	Ø	Ø	∪
6PSC469RG	30	45	55
6PSC470RG	30	48	80

C **EMPEROR RAW GREY**

ART. CODE	Ø	Ø	∪
6PSC474RG	24	39	90

D **DARCY RAW GREY**

ART. CODE	Ø	Ø	∪
6PSC321RG	23	33	33
6PSC711RG	32	47	57
6PSC114RG	47	62	60
6PSC115RG	43	56	72





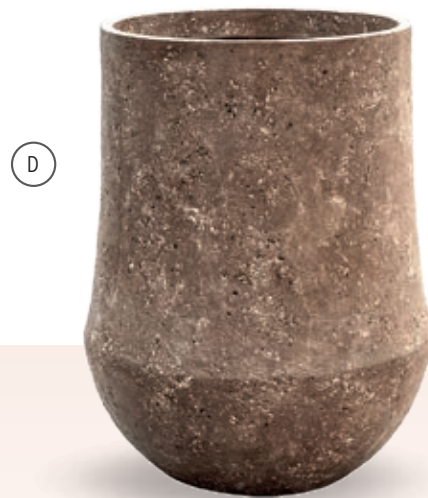

Photo: Polystone Coated Plain Coppa Rock

POLYSTONE COATED COLLECTION



POLYSTONE COATED PLAIN

A	BALLOON ROCK			
	ART. CODE	☉	☼	☽
	6PSC463RK	27	42	42
	6PSC464RK	30	48	55
	6PSC465RK	30	52	68

B	COPPA ROCK			
	ART. CODE	☉	☼	☽
	6PSC469RK	30	45	55
	6PSC470RK	30	48	80

C	EMPEROR ROCK			
	ART. CODE	☉	☼	☽
	6PSC474RK	24	39	90

D	DARCY ROCK			
	ART. CODE	☉	☼	☽
	6PSC321RC	23	33	33
	6PSC711RC	32	47	57
	6PSC114RC	47	62	60
	6PSC115RC	43	56	72





Photo: Polystone Coated Junar Couple Rock

POLYSTONE COATED COLLECTION



(B)



(A)



(C)



POLYSTONE COATED JUNAR

(A) COUPLE RAW GREY

ART. CODE	⊙	⊗	⊔
6PSC852RG	47	55	44
6PSC854RG	61	70	56
6PSC855RG	77	90	72
6PSC853RG	135	150	120

(B) COUPLE ROCK

ART. CODE	⊙	⊗	⊔
6PSC852RK	47	55	44
6PSC854RK	61	70	56
6PSC855RK	77	90	72
6PSC853RK	135	150	120

(C) COUPLE NATURAL

ART. CODE	⊙	⊗	⊔
6PSC852NT	47	55	44
6PSC854NT	61	70	56
6PSC855NT	77	90	72
6PSC853NT	135	150	120





Photo: Polystone Coated Ribbed Couple Raw Grey

POLYSTONE COATED COLLECTION



POLYSTONE COATED RIBBED

A	BALLOON RAW GREY	<input checked="" type="checkbox"/>	<input checked="" type="checkbox"/>	<input type="checkbox"/>
	ART. CODE	<input checked="" type="checkbox"/>	<input checked="" type="checkbox"/>	<input type="checkbox"/>
	6PSC689RG	45	50	53
	6PSC691RG	65	80	73

B	COUPLE RAW GREY	<input checked="" type="checkbox"/>	<input checked="" type="checkbox"/>	<input type="checkbox"/>
	ART. CODE	<input checked="" type="checkbox"/>	<input checked="" type="checkbox"/>	<input type="checkbox"/>
	6PSC791RG	82	90	111

C	BALLOON ROCK	<input checked="" type="checkbox"/>	<input checked="" type="checkbox"/>	<input type="checkbox"/>
	ART. CODE	<input checked="" type="checkbox"/>	<input checked="" type="checkbox"/>	<input type="checkbox"/>
	6PSC689RC	45	50	53
	6PSC691RC	65	80	73

D	COUPLE ROCK	<input checked="" type="checkbox"/>	<input checked="" type="checkbox"/>	<input type="checkbox"/>
	ART. CODE	<input checked="" type="checkbox"/>	<input checked="" type="checkbox"/>	<input type="checkbox"/>
	6PSC791RC	82	90	111





TERRAZZO COLLECTION

NL De Terrazzo-collectie kenmerkt zich door een unieke afwerking. De plantenbakken hebben een luxe uitstraling door het effect van gemalen steen. Doordat de collectie van fiberstone gemaakt is, zijn de bakken licht van gewicht, maar ook zeer sterk. De bakken zijn uv- en vorstbestendig en zijn voorzien van een afwateringsgat, waardoor ze geschikt zijn voor buiten. Bij gebruik binnen dient een inzethoes gebruikt te worden.

DE Die Terrazzo-Kollektion zeichnet sich durch eine einzigartige Oberfläche aus. Die Pflanzgefäße haben ein luxuriöses Aussehen durch den Effekt von gebrochenem Stein. Da die Kollektion aus Fasergestein hergestellt wird, sind die Pflanzgefäße leicht, aber auch sehr stabil. Die Pflanzgefäße sind UV- und frostbeständig und verfügen über ein Drainageloch, so dass sie für den Außenbereich geeignet sind. Für Innenräume wird zusätzlich ein Einsatzgefäß benötigt.

EN The Terrazzo collection is characterised by a unique finish. The planters have a luxurious look due to the effect of crushed stone. Because the collection is made of fiberstone, the planters are lightweight but also very strong. The planters are UV- and frost-resistant and feature a drainage hole, making them suitable for outdoor use. When used indoors, a liner should be used.

FR La collection Terrazzo se caractérise par une finition unique. Les bacs à plantes ont un aspect luxueux grâce à l'effet de la pierre concassée. La collection étant composée de fiberstone, les bacs sont à la fois légers et très résistants. Les bacs à plantes sont résistants aux UV et au gel et sont dotés d'un trou de drainage, ce qui permet de les utiliser à l'extérieur. Une pochette doit être utilisée si le bac est installé à l'intérieur.



Photo: Terrazzo Couple Black



Photo: Terrazzo Cylinder Mocha

TERRAZZO COLLECTION

B



C



D



A



E



F



A

CYLINDER BLACK

ART. CODE	☉	☼	☽
6TZZCB115	35	37	32
6TZZCB114	41	43	38
6TZZCB113	50	52	44

B

DARCY BLACK

ART. CODE	☉	☼	☽
6TZZDB102	31	37	32
6TZZDB101	43	51	34
6TZZDB100	60	70	46

C

COUPLE BLACK

ART. CODE	☉	☼	☽
6TZZRB141	36	38	32
6TZZRB140	44	46	42
6TZZRB139	53	57	52

D

CYLINDER MOCHA

ART. CODE	☉	☼	☽
6TZZCM125	35	37	32
6TZZCM124	41	43	38
6TZZCM123	50	52	44

E

DARCY MOCHA

ART. CODE	☉	☼	☽
6TZZDM112	31	37	32
6TZZDM111	43	51	34
6TZZDM110	60	70	46

F

COUPLE MOCHA

ART. CODE	☉	☼	☽
6TZZRM151	36	38	32
6TZZRM150	44	46	42
6TZZRM149	53	57	52





NUCAST® COLLECTION

NL De Nucast® plantenbakken zijn gemaakt van gerecyclede papiercomposiet, een heel praktisch alternatief voor traditionele materialen zoals steen en metaal. Nucast® kan de meest natuurlijke texturen nabootsen en heeft als voordeel dat het vele malen lichter van gewicht is. Daarnaast zijn de plantenbakken recyclebaar en dus duurzaam!

DE Die Nucast®-Pflanzgefäße sind aus recyceltem Papierverbundstoff hergestellt, einer sehr zweckmäßigen Alternative zu herkömmlichen Werkstoffen wie Stein und Metall. Nucast® erlaubt die naturgetreue Nachahmung von Texturen und hat den Vorteil, dass das Gewicht nur einen Bruchteil beträgt. Darüber hinaus sind die Pflanzgefäße wiederverwertbar und somit nachhaltig!

EN The Nucast® planters are made from recycled paper composite, a very practical alternative to traditional materials such as stone and metal. Nucast® is a lightweight material that can be used to mimic most natural textures. It's also easy to recycle, making these planters an excellent sustainable choice!

FR Les bacs à plantes Nucast® sont fabriqués à partir de composite en papier recyclé, une alternative très pratique aux matériaux traditionnels comme la pierre et le métal. Nucast® peut imiter la plupart des textures naturelles et est beaucoup plus léger. De plus, ces bacs à plantes sont recyclables et donc durables !



Photo: Nucast® Couple Elephant Grey



Photo: Nucast® Couple Elephant Grey

NUCAST® COLLECTION



A COUPLE ELEPHANT GREY

ART. CODE	Ø	∅	∪
6NUCCEG31	24	31	35
6NUCCEG32	24	32	40
6NUCCEG49	38	49	50

B COUPLE ELEPHANT GREY

ART. CODE	Ø	∅	∪
6NUCCEG50	41	50	50
6NUCCEG65	59	65	65

C PARTNER ELEPHANT GREY

ART. CODE	Ø	∅	∪
6NUCPEG30	24	30	70
6NUCPEG37	27	37	90

D CYLINDER ELEPHANT GREY

ART. CODE	Ø	∅	∪
6NUCCEG33	24	33	34
6NUCCEG38	27	38	40
6NUCCEG52	38	52	50





NATURESCAST® COLLECTION

NL De plantenbakken uit de Naturescast® collectie hebben een natuurlijke uitstraling. De plantenbakken zijn gemaakt van bosrestanten zoals droge bladeren, takken en boomschors. Het materiaal is milieuvriendelijk, biologisch afbreekbaar en recyclebaar.

DE Die Pflanzgefäße aus der Naturescast®-Kollektion zeichnen sich durch eine natürliche Ausstrahlung aus. Hergestellt werden sie aus Rückständen aus der Forstwirtschaft, wie beispielsweise trockenem Laub, Zweigen und Baumrinden. Dieses Material ist umweltfreundlich, biologisch abbaubar und recyclingfähig.

EN The planters from the Naturescast® collection have a natural appearance. The planters are made from forest residues, such as dry leaves, twigs and bark. The material is eco-friendly, biodegradable and recyclable.

FR Les bacs à plantes de la collection Naturescast® ont un look naturel. Les produits utilisés pour fabriquer les bacs à plantes se trouvent en forêt : ce sont des feuilles mortes, des branches et de l'écorce. Le matériau est respectueux de l'environnement, biodégradable et recyclable.



Photo: Naturescast® Cylinder Natural



Photo: Naturescast® Cylinder Natural

NATURESCAST® COLLECTION

A COUPLE NATURAL

ART. CODE	⊙	⊗	⊔
6NACNAC12	24	31	35
6NACNAC10	24	32	40
6NACNAC08	38	49	50

C PARTNER NATURAL

ART. CODE	⊙	⊗	⊔
6NACNAP31	26	30	70
6NACNAP38	30	37	90

B COUPLE NATURAL

ART. CODE	⊙	⊗	⊔
6NACNAC51	44	50	50
6NACNAC65	59	65	65

D CYLINDER NATURAL

ART. CODE	⊙	⊗	⊔
6NACNAC06	24	33	40
6NACNAC04	27	38	40
6NACNAC02	38	52	50





Photo: Naturescast® Partner Grey + Naturescast® Couple Grey

NATURESCAST® COLLECTION

A COUPLE GREY

ART. CODE	⊗	⊘	⊔
6NACNAC32	24	31	35
6NACNAC30	24	32	40
6NACNAC28	38	49	50

C PARTNER GREY

ART. CODE	⊗	⊘	⊔
6NACNAP50	26	30	70
6NACNAP52	30	37	90

B COUPLE GREY

ART. CODE	⊗	⊘	⊔
6NACNAC80	44	50	50
6NACNAC85	59	65	65

D CYLINDER GREY

ART. CODE	⊗	⊘	⊔
6NACNAC26	24	33	34
6NACNAC24	27	38	40
6NACNAC22	38	52	50



RAINDROP COLLECTION

NL De Raindrop-collectie kenmerkt zich door de bijzondere structuur en dankt daar ook zijn naam aan. Het lijkt net of er regendruppels langs de bak stromen. De plantenbakken zijn licht van gewicht en gemaakt van fiberclay.

DE Charakteristisches Merkmal der Raindrop-Kollektion ist die besondere Struktur, der sie auch ihren Namen verdankt. Die Oberfläche wirkt, als ob Regentropfen an ihr herablaufen. Die Pflanzgefäße haben ein geringes Gewicht und sind aus Fiberclay gefertigt.

EN The Raindrop collection is characterised by the special texture to which it owes its name, as these planters always look like they've just been hit by a fresh rain shower. The Raindrop models are lightweight and made of fibreclay.

FR La collection Raindrop se caractérise par sa structure spéciale d'où vient son nom. On dirait que des gouttes de pluie coulent sur le bac. Les bacs à plantes sont fabriqués à partir de Fiberclay et donc très légers.



NL Gebruik een Baq inzethoes om deze plantenbak waterdicht te maken.

DE Verwenden Sie eine Baq-Einsatz, um diesen Pflanzgefäß wasserdicht zu machen.

EN Use a Baq liner to make this planter watertight.

FR Utilisez une pochette de Baq pour rendre cette bac à plantes étanche.



Photo: Raindrop Cube Beige



Photo: Raindrop Cube Anthracite

RAINDROP COLLECTION



A **GLOBE ANTHRACITE**

ART. CODE	☉	☼	☽
6RDPAT143	31	42	30
6RDPAT144	44	55	40

B **EMPEROR ANTHRACITE**

ART. CODE	☉	☼	☽
6RDPAT066	26	37	60
6RDPAT088	39	53	88

C **BOWL ANTHRACITE**

ART. CODE	☉	☼	☽
6RDPAT123	42	44	19
6RDPAT124	45	55	26

D **CYLINDER ANTHRACITE**

ART. CODE	☉	☼	☽
6RDPAT133	29	34	32
6RDPAT134	37	42	41
6RDPAT135	46	51	49

E **DARCY ANTHRACITE**

ART. CODE	☉	☼	☽
6RDPAT113	22	30	26
6RDPAT114	31	41	37

F **DARCY HIGH ANTHRACITE**

ART. CODE	☉	☼	☽
6RDPAT117	28	37	42
6RDPAT118	38	55	55

G **CUBE ANTHRACITE**

ART. CODE	↔	↗	☽
6RDPAT250	30	30	27
6RDPAT251	40	40	36
6RDPAT252	50	50	45

H **PARTNER ANTHRACITE**

ART. CODE	☉	☼	☽
6RDPAT062	28	32	62
6RDPAT079	38	42	79

I **COUPLE ANTHRACITE**

ART. CODE	☉	☼	☽
6RDPAT127	32	37	33
6RDPAT128	39	44	43
6RDPAT129	49	54	51

J **RECTANGLE ANTHRACITE**

ART. CODE	↔	↗	☽
6RDPAT153	70	23	23
6RDPAT154	80	30	30





Photo: Raindrop Couple Beige

RAINDROP COLLECTION



A **GLOBE BEIGE**

ART. CODE	☉	☌	☒
6RDPBE243	31	42	30
6RDPBE244	44	55	40

B **EMPEROR BEIGE**

ART. CODE	☉	☌	☒
6RDPBE066	26	37	60
6RDPBE088	39	53	88

C **BOWL BEIGE**

ART. CODE	☉	☌	☒
6RDPBE223	37	44	19
6RDPBE224	45	55	26

D **CYLINDER BEIGE**

ART. CODE	☉	☌	☒
6RDPBE233	29	34	32
6RDPBE234	37	42	41
6RDPBE235	46	51	49

E **DARCY BEIGE**

ART. CODE	☉	☌	☒
6RDPBE213	22	30	26
6RDPBE214	31	41	37

F **DARCY HIGH BEIGE**

ART. CODE	☉	☌	☒
6RDPBE217	28	37	42
6RDPBE218	38	55	55

G **CUBE BEIGE**

ART. CODE	↔	↗	☒
6RDPBE247	30	30	27
6RDPBE248	40	40	36
6RDPBE249	50	50	45

H **PARTNER BEIGE**

ART. CODE	☉	☌	☒
6RDPBE062	28	32	62
6RDPBE079	38	42	79

I **COUPLE BEIGE**

ART. CODE	☉	☌	☒
6RDPBE227	32	37	33
6RDPBE228	39	44	43
6RDPBE229	49	54	51

J **RECTANGLE BEIGE**

ART. CODE	↔	↗	☒
6RDPBE253	70	23	23
6RDPBE254	80	30	30



VERTICAL RIB COLLECTION

NL De Vertical Rib heeft een prachtig geribbeld oppervlak met een brede rand. De plantenbakken zijn gemaakt van Fiberclay, dit heeft dezelfde uitstraling als beton, maar is gemakkelijk te verplaatsen dankzij het lichte gewicht. De Vertical Rib-collectie is uv-bestendig, waardoor u de bak zowel binnen (uiteraard met inzethoes) als buiten kunt plaatsen.

DE Das Modell Vertical Rib hat eine attraktive, gerippte Oberfläche mit breitem Rand. Die Pflanzgefäße bestehen aus Fiberclay, das dieselbe Ausstrahlung hat wie Beton, aber aufgrund seines geringen Gewichts leicht transportiert werden kann. Die Vertical Rib-Kollektion ist UV-beständig, sodass Sie den Behälter sowohl im Innenbereich (natürlich mit Einsatz) als auch im Freien aufstellen können.

EN The Vertical Rib has a beautiful ribbed surface with a wide edge. The planters are made from Fiberclay, which has the same appearance as cement but is much lighter and therefore easier to move around. The Vertical Rib collection is UV resistant, so you can place the planter indoors (with a liner) or outside.

FR Le Vertical Rib a une magnifique surface à relief côtelé et un large bord. Les bacs à plantes sont fabriqués en Fiberclay, qui a le même aspect que le béton, mais est bien plus facile à déplacer comme ce matériau est léger. La collection Vertical Rib est résistante aux UV; vous pouvez ainsi placer le bac aussi bien à l'intérieur (naturellement avec une pochette de rangement) qu'à l'extérieur.



NL Gebruik een Baq inzethoes om deze plantenbak waterdicht te maken.

DE Verwenden Sie eine Baq-Einsatz, um diesen Pflanzgefäß wasserdicht zu machen.

EN Use a Baq liner to make this planter watertight.

FR Utilisez une pochette de Baq pour rendre cette bac à plantes étanche.



Photo: Vertical Rib Cylinder Beige



Photo: Vertical Rib Cylinder Beige

VERTICAL RIB COLLECTION



A

B

C



D



E



F



A CYLINDER ANTHRACITE

ART. CODE	Ø	Ø	h
6VRCA0024	19	23	24
6VRCA0030	26	30	31
6VRCA0040	36	40	40

B	ART. CODE	Ø	Ø	h
	6VRCA0047	26	30	47
	6VRCA0057	33	37	57
	6VRCA0065	41	45	65

C CYLINDER BEIGE

ART. CODE	Ø	Ø	h
6VRCB0024	19	23	24
6VRCB0030	26	30	31
6VRCB0040	36	40	40

D	ART. CODE	Ø	Ø	h
	6VRCB0047	26	30	47
	6VRCB0057	33	37	57
	6VRCB0065	41	45	65

E CYLINDER GREEN

ART. CODE	Ø	Ø	h
6VRCG0024	19	23	24
6VRCG0030	26	30	31
6VRCG0040	36	40	40

F	ART. CODE	Ø	Ø	h
	6VRCG0047	26	30	47
	6VRCG0057	33	37	57
	6VRCG0065	41	45	65



TREND SERIES

COLLECTIONS

DUNE

GRADIENT

OPUS

LAVA

FACETS

ANGLE

VOGUE

NL De Trend-serie bestaat uit diverse plantenbakken, die dankzij een modieus design perfect aansluiten op de huidige tijdgeest.

DE Die Serie Trend besteht aus verschiedenen Pflanzgefäßen, die dank Ihres modischen Designs perfekt zum heutigen Zeitgeist passen.

EN The Trend series consists of various planters which, thanks to their modern design, are perfectly in keeping with the spirit of the times.

FR La série Trend est constituée de plusieurs bacs à plantes, qui grâce à leur design tendance, trouvent parfaitement leur place dans un intérieur moderne.





LET'S CREATE



DUNE COLLECTION

NL De Dune-collectie heeft een prachtige oppervlaktestructuur die doet denken aan de dynamische lijnen van opgewaaide zandduinen. Deze plantenbakken zijn gemaakt van lichtgewicht fiberclay en zijn daardoor gemakkelijk te verplaatsen. Omdat ze uv-bestendig zijn en een afwateringsgat hebben, kunnen de plantenbakken gemakkelijk buiten worden geplaatst. Bij gebruik binnen dient een inzethoes gebruikt te worden.

DE Die Dune-Kollektion hat eine schöne Oberflächentextur, die an die dynamischen Linien erinnert, die in von Wind gepeitschten Sanddünen zu finden sind. Hergestellt aus leichtem Fibreclay, sind diese Pflanzgefäße einfach zu bewegen. Dank ihrer UV-beständigen Eigenschaften und des Drainagelochs können sie problemlos im Freien aufgestellt werden. Für Innenräume wird zusätzlich ein Einsatzgefäß benötigt.

EN The Dune collection has a beautiful surface texture reminiscent of the dynamic lines found in windblown sand dunes. Crafted from lightweight fibreclay, these planters are easy to move around. Thanks to their UV-resistant properties and drainage hole, they can be placed outdoors with ease. For indoor use, a liner should be used.

FR La collection Dune présente une belle texture de surface rappelant les lignes dynamiques des dunes de sable soufflées par le vent. Fabriqués en fibreclay léger, ces bacs à plantes sont faciles à déplacer. Grâce à leur résistance aux UV et à leur trou de drainage, ils peuvent être placés à l'extérieur en toute simplicité. Une pochette doit être utilisée si le bac est installé à l'intérieur.



Photo: Dune Cylinder Brown Beige + Dune Partner Brown Beige



Photo: Dune Cylinder Brown Beige + Dune Partner Brown Beige

DUNE COLLECTION



A PARTNER BEIGE

ART. CODE	☉	☼	☽
6DUNBE21A	18	25	40
6DUNBE21B	27	35	55
6DUNBE21C	37	48	75

B DARCY BEIGE

ART. CODE	☉	☼	☽
6DUNBE60A	23	30	26
6DUNBE60B	33	41	37

C

6DUNBE61B	30	38	43
6DUNBE61C	39	49	55

D CYLINDER BEIGE

ART. CODE	☉	☼	☽
6DUNBE62B	32	38	37
6DUNBE62C	40	44	44
6DUNBE62D	48	53	52

E PARTNER BROWN BEIGE

ART. CODE	☉	☼	☽
6DUNBR21A	18	25	40
6DUNBR21B	27	35	55
6DUNBR21C	37	48	75

F DARCY BROWN BEIGE

ART. CODE	☉	☼	☽
6DUNBR60A	23	30	26
6DUNBR60B	33	41	37

G

6DUNBR61B	30	38	43
6DUNBR61C	39	49	55

H CYLINDER BROWN BEIGE

ART. CODE	☉	☼	☽
6DUNBR62B	32	38	37
6DUNBR62C	40	44	44
6DUNBR62D	48	53	52





GRADIENT COLLECTION

NL De plantenbakken uit de Gradient-collectie hebben een subtiel handgespoten kleurverloop kleurverloop dat zorgt voor een harmonieuze uitstraling. De plantenbakken zijn gemaakt van Polyresin, een stevig materiaal dat bestaat uit een mengsel van hars en gemalen steen.

DE Die Pflanzgefäße der Gradient-Kollektion werden von Hand mit einem subtilen Farbverlauf lackiert, wodurch eine harmonische Ausstrahlung entsteht. Als Werkstoff wird Polyresin verwendet, einer Mischung aus Kunstharz und gemahlenem Stein.

EN The Gradient planters feature a subtle, hand-sprayed colour gradient that creates a harmonious look. The models in this collection are made of polyresin, a solid material consisting of a mixture of ground stone and liquid synthetic resin.

FR Les bacs à plantes dans la collection Gradient sont tous peints à la main pour créer un dégradé de couleurs subtil et un look harmonieux. Ils sont fabriqués à partir de polyrésine, un matériau solide constitué d'un mélange de pierre broyée et de résine synthétique liquide.





Photo: Gradient Partner Matt Grey









Photo: Gradient Partner Matt Coffee



GRADIENT COLLECTION



A BALLOON MATT COFFEE
ART. CODE   
 6GRDB54CB 44 54 51
 6GRDB70CB 57 70 68

B COUPLE MATT COFFEE
ART. CODE   
 6GRDC70CB 58 70 56
 6GRDC90CB 76 90 70

C PARTNER MATT COFFEE
ART. CODE   
 6GRDP47CB 36 40 75
 6GRDP49CB 36 40 95

D HANGING BASKET MATT COFFEE
ART. CODE   
 6GRDH21CB 19 21 21

E HANGING BOWL MATT COFFEE
ART. CODE   
 6GRDH33CB 23 33 21
 6GRDH38CB 28 38 24

F HANGING COCOON MATT COFFEE
ART. CODE   
 6GRDH20CB 18 20 24

G HANGING GLOBE MATT COFFEE
ART. CODE   
 6GRDH24CB 22 24 19

GRADIENT ACCESSORIES

H CHAIN EXTENSION
ART. CODE 
 6DHMHCE02 100





Photo: Gradient Hanging Basket Matt Grey + Gradient Hanging Cocoon Matt Grey

GRADIENT COLLECTION



A **BALLOON MATT GREY**
ART. CODE
 6GRDB54GR 44 54 51
 6GRDB70GR 57 70 68

B **COUPLE MATT GREY**
ART. CODE
 6GRDC70GR 58 70 56
 6GRDC90GR 76 90 70

C **PARTNER MATT GREY**
ART. CODE
 6GRDP47GR 36 40 75
 6GRDP49GR 36 40 95

D **HANGING BASKET MATT GREY**
ART. CODE
 6GRDH21GR 19 21 21

E **HANGING BOWL MATT GREY**
ART. CODE
 6GRDH33GR 23 33 21
 6GRDH38GR 28 38 24

F **HANGING COCOON MATT GREY**
ART. CODE
 6GRDH20GR 18 20 24

G **HANGING GLOBE MATT GREY**
ART. CODE
 6GRDH24GR 22 24 19

GRADIENT ACCESSORIES

H **CHAIN EXTENSION**
ART. CODE
 6DHMHCE02 100





Photo: Gradient Balloon Matt Honey

GRADIENT COLLECTION



A BALLOON MATT HONEY
ART. CODE
 6GRDB54HB 44 54 51
 6GRDB70HB 57 70 68

B COUPLE MATT HONEY
ART. CODE
 6GRDC70HB 58 70 56
 6GRDC90HB 76 90 70

C PARTNER MATT HONEY
ART. CODE
 6GRDP47HB 36 40 75
 6GRDP49HB 36 40 95

D HANGING BASKET MATT HONEY
ART. CODE
 6GRDH21HB 19 21 21

E HANGING BOWL MATT HONEY
ART. CODE
 6GRDH33HB 23 33 21
 6GRDH38HB 28 38 24

F HANGING COCOON MATT HONEY
ART. CODE
 6GRDH20HB 18 20 24

G HANGING GLOBE MATT HONEY
ART. CODE
 6GRDH24HB 22 24 19

GRADIENT ACCESSORIES

H CHAIN EXTENSION
ART. CODE
 6DHMHCE02 100





Photo: Gradient Couple Matt Forest Green

GRADIENT COLLECTION

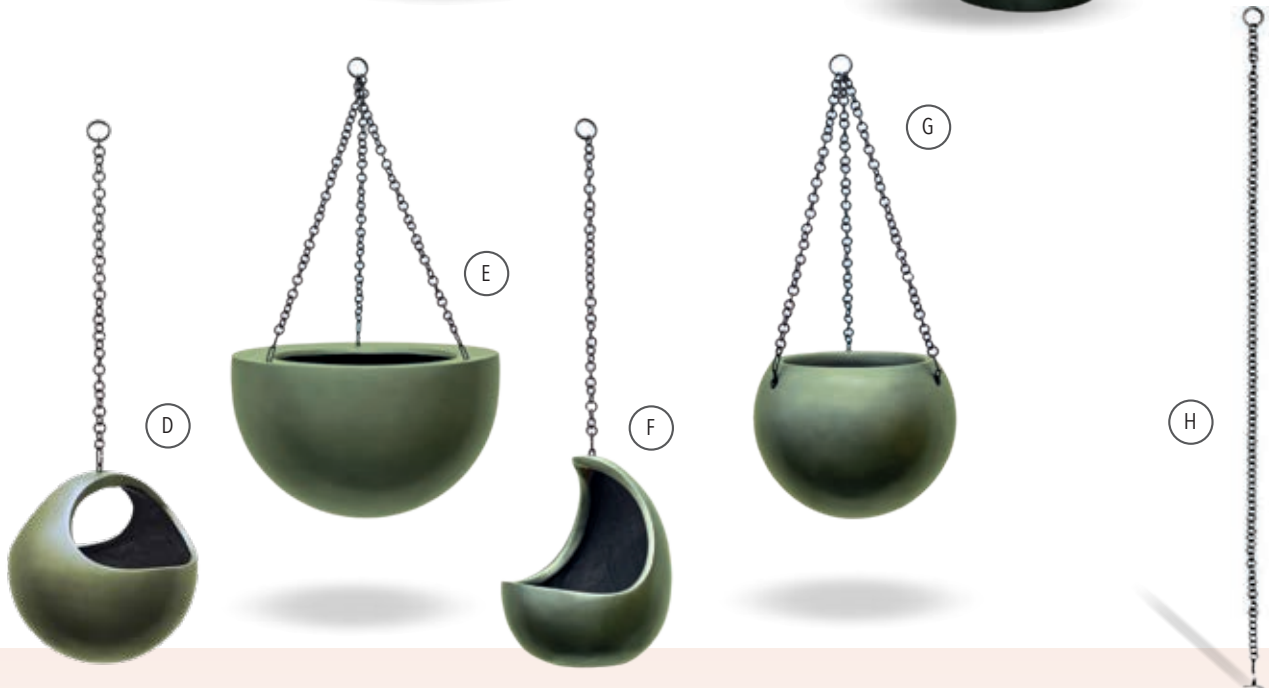

A BALLOON MATT
FOREST GREEN

ART. CODE	☉	☑	☒
6GRDB540G	44	54	51
6GRDB700G	57	70	68

B COUPLE MATT
FOREST GREEN

ART. CODE	☉	☑	☒
6GRDC700G	58	70	56
6GRDC900G	76	90	70

C PARTNER MATT
FOREST GREEN

ART. CODE	☉	☑	☒
6GRDP470G	36	40	75
6GRDP490G	36	40	95

D HANGING BASKET MATT
FOREST GREEN

ART. CODE	☉	☑	☒
6GRDH210G	19	21	21

E HANGING BOWL MATT
FOREST GREEN

ART. CODE	☉	☑	☒
6GRDH330G	23	33	21
6GRDH380G	28	38	24

F HANGING COCOON
MATT FOREST GREEN

ART. CODE	☉	☑	☒
6GRDH200G	18	20	24

G HANGING GLOBE MATT
FOREST GREEN

ART. CODE	☉	☑	☒
6GRDH240G	22	24	19

GRADIENT ACCESSORIES

H CHAIN
EXTENSION

ART. CODE	↔
6DHMHCE02	100





Photo: Gradient Lee Couple Matt Coffee + Gradient Lee Partner Matt Coffee

GRADIENT COLLECTION

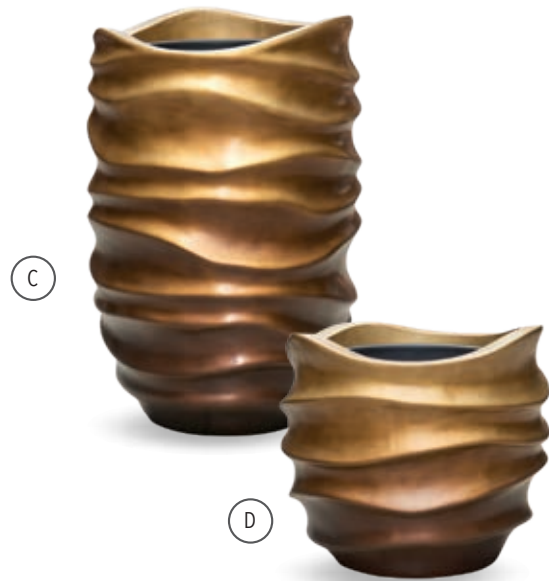

GRADIENT LEE

A PARTNER MATT COFFEE

ART. CODE	☉	☑	☒
6GRDP40CO	27	40	61
6GRDP60CO	41	60	88

B COUPLE MATT COFFEE

ART. CODE	☉	☑	☒
6GRDC41CO	27	41	37
6GRDC61CO	41	61	49

C PARTNER MATT HONEY BROWN

ART. CODE	☉	☑	☒
6GRDP40HB	27	40	61
6GRDP60HB	41	60	88

D COUPLE MATT HONEY BROWN

ART. CODE	☉	☑	☒
6GRDC41HB	27	41	37
6GRDC61HB	41	61	49

E PARTNER MATT GREY

ART. CODE	☉	☑	☒
6GRDP40GR	27	40	61
6GRDP60GR	41	60	88

F COUPLE MATT GREY

ART. CODE	☉	☑	☒
6GRDC41GR	27	41	37
6GRDC61GR	41	61	49

G PARTNER MATT FOREST GREEN

ART. CODE	☉	☑	☒
6GRDP40MG	27	40	61
6GRDP60MG	41	60	88

H COUPLE MATT FOREST GREEN

ART. CODE	☉	☑	☒
6GRDC41MG	27	41	37
6GRDC61MG	41	61	49





OPUS COLLECTION

NL De Opus-collectie is gemaakt van lichtgewicht polystone met een bijzondere oppervlakte-structuur die lijkt op gehamerd metaal. Dankzij een speciale afwerkingstechniek, is het materiaal van de plantenbak nauwelijks van echt metaal te onderscheiden.

DE Die Opus-Kollektion besteht aus leichtem Polystone mit einer speziellen Oberflächenstruktur, die an gehämmertes Metall erinnert. Dank einer speziellen Veredelungstechnik ist das Material des Pflanzgefäßes kaum von echtem Metall zu unterscheiden.

EN The Opus collection is made of lightweight polystone with a special surface structure that resembles hammered metal. Thanks to a special finishing technique, the material of the planter can hardly be distinguished from real metal.

FR La collection Opus a des bacs dont la surface a une structure très particulière, ressemblant au métal martelé. Grâce à une technique de finition spéciale, le matériau de ces bacs à plantes se distingue à peine du vrai métal et très léger. Les bacs à plantes sont livrés avec un bac intérieur imperméable et assorti.



Photo: Opus Hammered Globe Silver + Opus Hammered Partner Silver



Photo: Opus Hammered Globe Silver + Opus Hammered Partner Silver

OPUS COLLECTION



OPUS HAMMERED

A

GLOBE GOLD

ART. CODE	☉	☽	☼
60PSC43HG	27	40	32
60PSC64HG	41	60	43

B

PARTNER GOLD

ART. CODE	☉	☽	☼
60PSP37HG	24	35	75
60PSP39HG	24	35	97

C

GLOBE SILVER

ART. CODE	☉	☽	☼
60PSC43HS	27	40	32
60PSC64HS	41	60	43

D

PARTNER SILVER

ART. CODE	☉	☽	☼
60PSP37HS	24	35	75
60PSP39HS	24	35	97





Photo: Opus Hit Darcy Silver

OPUS COLLECTION



OPUS
HIT

A	DARCY GOLD			
	ART. CODE	⊙	⊘	⊔
	60PSD38RG	24	38	42
	60PSD45RG	30	45	48
60PSD59RG	38	59	69	
B	60PSD40RG	32	46	100

C	DARCY SILVER			
	ART. CODE	⊙	⊘	⊔
	60PSD38RS	24	38	42
	60PSD45RS	30	45	48
60PSD59RS	38	59	69	
D	60PSD40RS	32	46	100





Photo: Opus Raw Couple Gold

OPUS COLLECTION



OPUS RAW

(A) COUPLE GOLD

ART. CODE			
60PSC33RG	23	38	30
60PSC54RG	31	50	40
60PSC65RG	41	65	53

(B) PARTNER GOLD

ART. CODE			
60PSP36RG	24	31	65
60PSP48RG	33	40	85
60PSP51RG	41	50	105

(C) COUPLE SILVER

ART. CODE			
60PSC33RS	23	38	30
60PSC54RS	31	50	40
60PSC65RS	41	65	53

(D) PARTNER SILVER

ART. CODE			
60PSP36RS	24	31	65
60PSP48RS	33	40	85
60PSP51RS	41	50	105



LAVA COLLECTION

NL De Lava-collectie kenmerkt zich door een grillig oppervlak, dat is ontstaan door een speciale techniek die wij "scratch off" noemen. Deze keramische plantenbakken worden op ambachtelijke wijze gemaakt in houtgestookte ovens. Elk product is uniek en geen twee zijn hetzelfde. De indoor plantenbakken zijn waterdicht en beschikken over antirasviltjes aan de onderkant. De outdoor plantenbakken zijn voorzien van een gat in de bodem, zodat het overtollige water kan worden afgevoerd. Door het gebruik van natuurlijke materialen kunnen getoonde kleuren afwijken van de werkelijkheid.

DE Die Lava-Kollektion zeichnet sich durch eine eigenwillige Oberfläche aus, die durch eine Spezialtechnik entsteht, die wir „Scratch off“ nennen. Diese Keramikpflanzgefäße werden auf traditionelle Weise in Holzöfen gebrannt. Jedes Produkt ist einzigartig. Die Pflanzgefäße für den Innenbereich sind wasserdicht und an der Unterseite mit Kratzschutznoppen versehen. Die Pflanzgefäße für den Außenbereich verfügen über ein Loch im Boden, sodass überschüssiges Wasser ablaufen kann. Die Farbe kann aufgrund der Verwendung von natürlichen Materialien abweichen.

EN The Lava collection is distinctive because of its unusual surface, which is created by a special technique that we call 'scratch off'. These ceramic planters are made in the traditional way using wood fired ovens. Each product is unique, which means that no two planters are the same. The indoor planters are watertight and have anti-scratch felt underneath the base. The outdoor planters have a hole in the base to drain off excess water. Due to the use of natural materials, the colors shown may differ from reality.

FR La collection Lava se caractérise par une surface inégale des bacs, obtenue grâce à une technique spéciale appelée « scratch off ». Ces bacs à plantes en céramique sont produits artisanalement dans des fours chauffés au bois. Chaque produit est unique et il n'y en a pas deux d'identique. Les bacs à plantes d'intérieur sont imperméables et ont des feutres contre les rayures placés sur le dessous. Les bacs à plantes d'extérieur ont un trou dans le fond du bac, permettant d'évacuer l'excédent d'eau. En raison de l'utilisation de matériaux naturels, les couleurs présentées peuvent différer de la réalité.



Photo: Lava Coppa Relic Black



Photo: Lava Balloon Relic Jade

LAVA COLLECTION

A EMPEROR
RELIC JADE

ART. CODE	⊗	⊘	∪
6LAVE750J	31	45	75
6LAVE950J	39	57	95

B BALLOON
RELIC JADE

ART. CODE	⊗	⊘	∪
6LAVG430J	32	49	43
6LAVG500J	37	54	50
6LAVG550J	42	60	55

C 6LAVG730J 46 73 80
6LAVG850J 55 85 80

D COPPA
RELIC JADE

ART. CODE	⊗	⊘	∪
6LAVR680J	36	50	68
6LAVR830J	43	58	83

E COUPLE
RELIC JADE

ART. CODE	⊗	⊘	∪
6LAVC340J	30	36	34
6LAVC420J	36	45	42
6LAVC480J	48	55	48

F BOWL
RELIC JADE

ART. CODE	⊗	⊘	∪
6LAVB240J	33	40	24
6LAVB290J	44	52	29

G PARTNER STRAIGHT
RELIC JADE

ART. CODE	⊗	⊘	∪
6LAVP650J	29	35	65
6LAVP850J	40	46	85



H PARTNER
RELIC JADE

ART. CODE	⊗	⊘	∪
6LAVP105J	49	55	105





Photo: Lava Coppa Relic Black

LAVA COLLECTION

A EMPEROR
RELIC BLACK

ART. CODE			
6LAVE750Z	31	45	75
6LAVE950Z	39	57	95

B BALLOON
RELIC BLACK

ART. CODE			
6LAVG430Z	32	49	43
6LAVG500Z	37	54	50
6LAVG550Z	42	60	55

C 6LAVG730B 46 73 80
6LAVG850B 55 85 80

D COPPA
RELIC BLACK

ART. CODE			
6LAVR680Z	36	50	68
6LAVR830Z	43	58	83

E COUPLE
RELIC BLACK

ART. CODE			
6LAVC340Z	30	36	34
6LAVC420Z	38	45	42
6LAVC480Z	48	55	48

F BOWL
RELIC BLACK

ART. CODE			
6LAVB240Z	33	40	24
6LAVB290Z	44	52	29

G PARTNER STRAIGHT
RELIC BLACK

ART. CODE			
6LAVP650Z	29	35	65
6LAVP850Z	40	46	85



H PARTNER
RELIC BLACK

ART. CODE			
6LAVP105Z	49	55	105





Photo: Lava Partner Straight Relic Pink

LAVA COLLECTION

**(A) EMPEROR
RELIC PINK**

ART. CODE			
6LAVE750P	31	45	75
6LAVE950P	39	57	95



**(B) BALLOON
RELIC PINK**

ART. CODE			
6LAVG430P	32	49	43
6LAVG500P	37	54	50
6LAVG550P	42	60	55

(C) 6LAVG730P	46	73	80
6LAVG850P	55	85	80

**(D) COPPA
RELIC PINK**

ART. CODE			
6LAVR680P	36	50	68
6LAVR830P	43	58	83

**(E) COUPLE
RELIC PINK**

ART. CODE			
6LAVC340P	30	36	34
6LAVC420P	38	45	42
6LAVC480P	48	55	48

**(F) BOWL
RELIC PINK**

ART. CODE			
6LAVB240P	33	40	24
6LAVB290P	44	52	29

**(G) PARTNER STRAIGHT
RELIC PINK**

ART. CODE			
6LAVP650P	29	35	65
6LAVP850P	40	46	85

**(H) PARTNER
RELIC PINK**

ART. CODE			
6LAVP105P	49	55	105





Photo: Lava Balloon Relic Rust Metal

LAVA COLLECTION

**(A) EMPEROR
RELIC RUST METAL**

ART. CODE			
6LAVE750M	31	45	75
6LAVE950M	39	57	95

**(B) BALLOON
RELIC RUST METAL**

ART. CODE			
6LAVG430M	32	49	43
6LAVG500M	37	54	50
6LAVG550M	42	60	55

**(C) COPPA
RELIC RUST METAL**

ART. CODE			
6LAVR680M	36	50	68
6LAVR830M	43	58	83

**(D) COUPLE
RELIC RUST METAL**

ART. CODE			
6LAVC340M	30	36	34
6LAVC420M	38	45	42
6LAVC480M	48	55	48

**(E) BOWL
RELIC RUST METAL**

ART. CODE			
6LAVB240M	33	40	24
6LAVB290M	44	52	29

**(F) PARTNER STRAIGHT
RELIC RUST METAL**

ART. CODE			
6LAVP650M	29	35	65
6LAVP850M	40	46	85

**(G) PARTNER
RELIC RUST METAL**

ART. CODE			
6LAVP105M	49	55	105





Photo: Lava Cube Relic Jade + Lava Oval Relic Beige

LAVA COLLECTION



A COUPLE STRAIGHT
RELIC BEIGE

ART. CODE	☉	☒	☒
6LAVR130B	17	19	13
6LAVR170B	23	25	17

B OVAL
RELIC BEIGE

ART. CODE	↔	↗	☒
6LAVO150B	31	18	15
6LAVO190B	38	24	19

C CUBE
RELIC BEIGE

ART. CODE	↔	↗	☒
6LAVS160B	16	16	16
6LAVS200B	22	22	20

D COUPLE STRAIGHT
RELIC JADE

ART. CODE	☉	☒	☒
6LAVR130J	17	19	13
6LAVR170J	23	25	17

E OVAL
RELIC JADE

ART. CODE	↔	↗	☒
6LAVO150J	31	18	15
6LAVO190J	38	24	19

F CUBE
RELIC JADE

ART. CODE	↔	↗	☒
6LAVS160J	16	16	16
6LAVS200J	22	22	20

G COUPLE STRAIGHT
RELIC PINK

ART. CODE	☉	☒	☒
6LAVR130P	17	19	13
6LAVR170P	23	25	17

H OVAL
RELIC PINK

ART. CODE	↔	↗	☒
6LAVO150P	31	18	15
6LAVO190P	38	24	19

I CUBE
RELIC PINK

ART. CODE	↔	↗	☒
6LAVS160P	16	16	16
6LAVS200P	22	22	20

J COUPLE STRAIGHT
RELIC RUST METAL

ART. CODE	☉	☒	☒
6LAVR130M	17	19	13
6LAVR170M	23	25	17

K OVAL
RELIC RUST METAL

ART. CODE	↔	↗	☒
6LAVO150M	31	18	15
6LAVO190M	38	24	19

L CUBE
RELIC RUST METAL

ART. CODE	↔	↗	☒
6LAVS160M	16	16	16
6LAVS200M	22	22	20



M COUPLE STRAIGHT
RELIC BLACK

ART. CODE	☉	☒	☒
6LAVR130Z	17	19	13
6LAVR170Z	23	25	17

N OVAL
RELIC BLACK

ART. CODE	↔	↗	☒
6LAVO150Z	31	18	15
6LAVO190Z	38	24	19

O CUBE
RELIC BLACK

ART. CODE	↔	↗	☒
6LAVS160Z	16	16	16
6LAVS200Z	22	22	20





FACETS COLLECTION

NL De plantenbakken uit de Facets-collectie halen de schoonheid van de natuur naar binnen. De plantenbakken zijn gemaakt van fiberresin en worden handmatig versierd met natuurlijke materialen. De prachtige afwerking maakt het een echte blikvanger! Deze plantenbakken worden geleverd inclusief een bijpassende waterdichte binnenbak. Door het gebruik van natuurlijke materialen kunnen getoonde kleuren afwijken van de werkelijkheid. Houd er rekening mee dat deze plantenbakken, vanwege de natuurlijke materialen, kunnen krimpen en uitzetten.

DE Die Pflanzgefäße aus der Facets-Kollektion bringen die Schönheit der Natur ins Haus. Sie bestehen aus einer Faser-Harz-Mischung und werden mit der Hand mit natürlichen Materialien dekoriert. Diese attraktive Verarbeitung macht daraus echte Eyecatcher! Diese Pflanzgefäße werden mit einem passenden wasserdichten Einsatz geliefert. Die Farbe kann aufgrund der Verwendung von natürlichen Materialien abweichen. Denken Sie daran, dass diese Pflanzgefäße aufgrund der natürlichen Materialien schrumpfen und sich ausdehnen können.

EN The planters from the Facets collection bring the beauty of nature indoors. The planters are made from fibre resin and hand decorated with natural materials. The beautiful finish of these planters is really eye-catching! These planters come with a matching watertight liner. Due to the use of natural materials, the colors shown may differ from reality. Please note that these planters may shrink and expand due to the natural materials.

FR Les bacs à plantes de la collection Facets font entrer la beauté de la nature dans l'intérieur. Ces bacs à plantes sont fabriqués à partir de résine synthétique et sont décorés à la main avec des matériaux naturels. Grâce à la finition magnifique, ils attirent assurément l'attention ! Ces bacs à plantes sont fournis avec une pochette imperméable et assorti. En raison de l'utilisation de matériaux naturels, les couleurs présentées peuvent différer de la réalité. Gardez à l'esprit qu'en raison des matériaux naturels, bacs à plantes peuvent rétrécir et s'étendre.

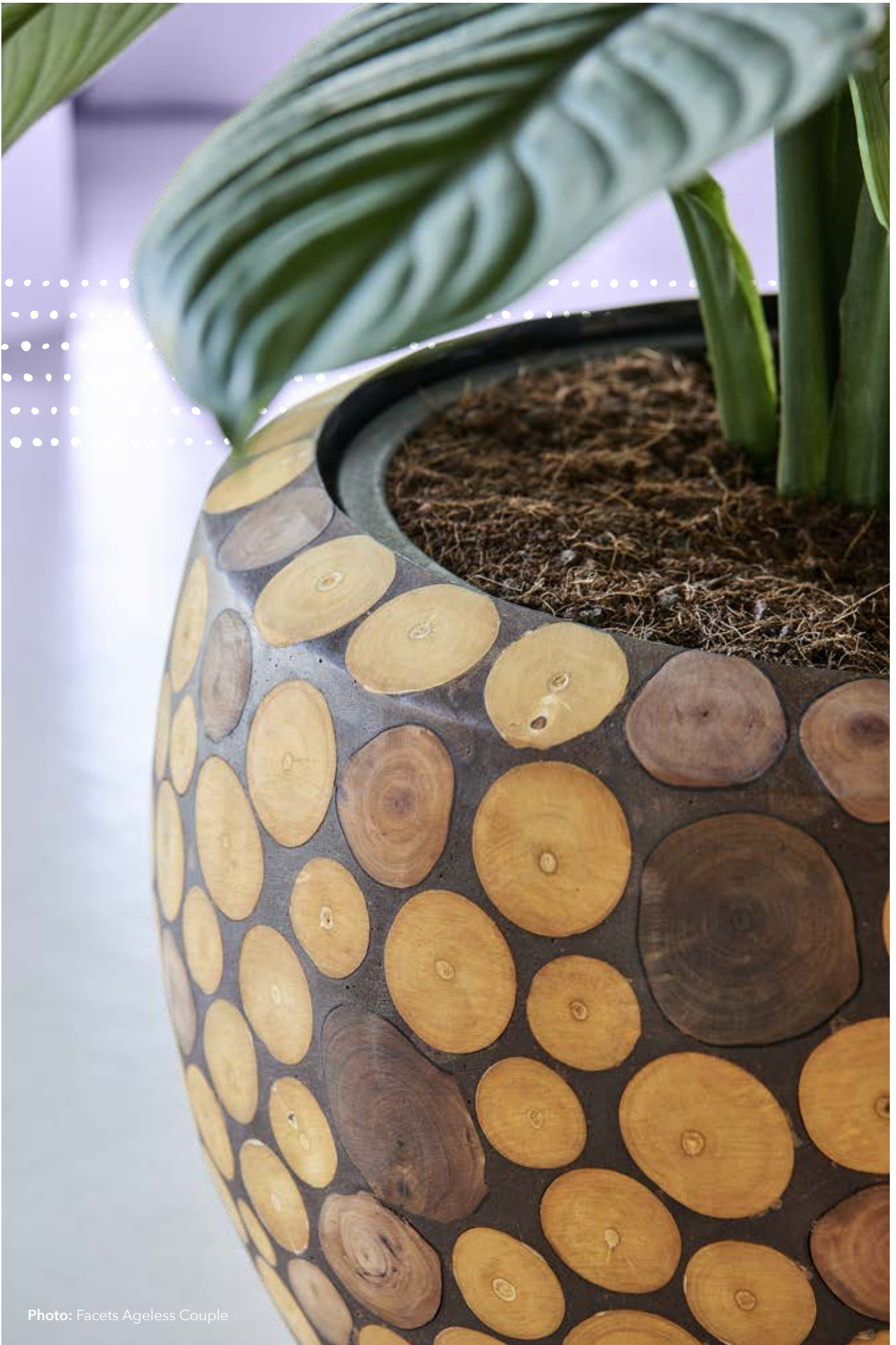

Photo: Facets Ageless Couple



Photo: Facets Jenga Partner

FACETS COLLECTION



FACETS AGELESS

(A)	COUPLE			
	ART. CODE			
	6FACEC128	30	42	37
	6FACEC828	38	50	45

(B)	PARTNER			
	ART. CODE			
	6FACEP428	27	35	70
	6FACEP528	30	41	90

FACETS JENGA

(C)	COUPLE			
	ART. CODE			
	6FACEC620	11	17	15
	6FACEC820	38	50	45

(D)	PARTNER			
	ART. CODE			
	6FACEP420	27	35	70
	6FACEP520	30	41	90





ANGLE COLLECTION

NL De handgemaakte plantenbakken uit de Angle-collectie hebben een betonnen uitstraling met een prachtig 'geweven' structuur op de oppervlakte. Deze unieke combinatie maakt de collectie zo bijzonder. De plantenbakken zijn gemaakt van Fiberclay, waardoor ze licht zijn van gewicht en gemakkelijk te verplaatsen zijn. Bovendien is de Angle collectie voorzien van een afwateringsgat, uv- en vorstbestendig, waardoor de bakken zowel binnen als buiten geplaatst kunnen worden. Bij gebruik binnen dient er een inzethoes gebruikt te worden.

DE Die handgefertigten Pflanzgefäße aus der Angle-Kollektion haben eine Betonoptik mit einem schönen „gewebten“ Struktur auf der Oberfläche. Diese einzigartige Kombination macht die Kollektion so besonders. Die Pflanzgefäße sind aus Fiberclay gefertigt, was sie leicht und einfach zu bewegen macht. Außerdem ist die Angle-Kollektion mit einer Drainageloch versehen, UV- und frostbeständig, so dass die Gefäße sowohl im Innen- als auch im Außenbereich aufgestellt werden können. Für Innenräume wird zusätzlich ein Einsatz benötigt.

EN The handmade planters from the Angle collection have a concrete look with a beautiful 'woven' structure on the surface. This unique combination makes the collection so special. The planters are made from Fibreclay, which results in them being lightweight and easy to move around. In addition, the Angle collection is provided with a drainage hole, and is UV and frost resistant, allowing the planters to be used both indoors and outdoors. For indoor use, a liner should be used.

FR Les bacs à plantes fabriqués à la main de la collection Angle ont un aspect béton avec un bel effet "tissé" sur la surface. C'est cette combinaison unique qui rend la collection si spéciale. Les bacs à plantes sont fabriqués en Fiberclay, ce qui les rend légers et faciles à déplacer. Ces bacs conviennent également à une utilisation en extérieur, car ils sont tous dotés d'un trou de drainage et résistent aux UV et au gel. Une pochette doit être utilisée si le bac est installé à l'intérieur.



Photo: Angle Cylinder Anthracite



Photo: Angle Cylinder Anthracite

ANGLE COLLECTION



A COUPLE ANTHRACITE
ART. CODE
 6ANGCO23A 22 24 23
 6ANGCO28A 28 30 28

B CYLINDER ANTHRACITE
ART. CODE
 6ANGCY24A 22 24 24
 6ANGCY30A 28 30 30

C DARCY ANTHRACITE
ART. CODE
 6ANGCO16A 22 24 16
 6ANGCO24A 32 35 24

D COUPLE GREY
ART. CODE
 6ANGCO23G 22 24 23
 6ANGCO28G 28 30 28

E CYLINDER GREY
ART. CODE
 6ANGCY24G 22 24 24
 6ANGCY30G 28 30 30

F DARCY GREY
ART. CODE
 6ANGCO16G 22 24 16
 6ANGCO24G 32 35 24

G COUPLE WHITE
ART. CODE
 6ANGCO23W 22 24 23
 6ANGCO28W 28 30 28

H CYLINDER WHITE
ART. CODE
 6ANGCY24W 22 24 24
 6ANGCY30W 28 30 30

I DARCY WHITE
ART. CODE
 6ANGCO16W 22 24 16
 6ANGCO24W 32 35 24





VOGUE COLLECTION

NL De plantenbakken uit de Vogue-collectie worden met de hand versierd en zijn voorzien van prachtige patronen. De plantenbakken zijn gemaakt van Polyresin, een stevig materiaal dat bestaat uit een mengsel van gemalen steen met vloeibare kunstharz. Deze plantenbakken worden geleverd inclusief een bijpassende waterdichte binnenbak.

DE Die Pflanzgefäße der Vogue-Kollektion werden von Hand dekoriert und sind mit wunderschönen Mustern verziert. Die Pflanzgefäße werden aus Polyresin hergestellt, einer Mischung aus Kunstharz und gemahlenem Stein. Eine passende, wasserdichte Einsatz ist im Lieferumfang enthalten.

EN The Vogue planters are decorated by hand and feature beautiful patterns. These models are made of polyresin, a solid material consisting of a mixture of ground stone and liquid synthetic resin. Each Line-up model comes with a matching waterproof liner.

FR Les bacs à plantes dans la collection Vogue sont décorés à la main avec de magnifiques dessins. Ils sont fabriqués à partir de polyrésine, un matériau solide constitué d'un mélange de pierre broyée et de résine synthétique liquide. Ces bacs à plantes sont livrés avec une pochette étanche assorti.



Photo: Vogue Amfi Partner Snake Red



Photo: Vogue Sensation Partner Orange Brown



VOGUE COLLECTION



VOGUE AMFI

A PARTNER SNAKE BLACK

ART. CODE	⊗	⊘	∪
6AMFP43SB	33	43	68
6AMFP75SB	24	34	75
6AMFP97SB	24	34	97

B PARTNER SNAKE RED

ART. CODE	⊗	⊘	∪
6AMFP43SR	33	43	68
6AMFP75SR	24	34	75
6AMFP97SR	24	34	97

C PARTNER SNAKE WHITE

ART. CODE	⊗	⊘	∪
6AMFP43SW	36	43	68
6AMFP75SW	24	34	75
6AMFP97SW	24	34	97

VOGUE SENSATION

D PARTNER AQUA BLUE

ART. CODE	⊗	⊘	∪
6VOGP40AB	36	40	75

E PARTNER ORANGE BROWN

ART. CODE	⊗	⊘	∪
6VOGP40OB	36	40	75



ACCESSORIES SERIES



COLLECTIONS

LINER

NL Met het gebruik van slimme accessoires wordt het assembleren van planten nog eenvoudiger. Deze accessoires zijn speciaal ontwikkeld voor de diverse Baq plantenbakken series en zijn van hoogwaardige kwaliteit.

DE Durch den Einsatz von intelligentem Zubehör wird die Montage von Anlagen noch einfacher. Dieses Zubehör wurde speziell für die verschiedenen Baq-Pflanzgefäße entwickelt und ist von hoher Qualität.

EN With the use of smart accessories, assembling plants becomes even easier. These accessories have been specially developed for the various Baq planter series and are of high quality.

FR Avec l'utilisation d'accessoires intelligents, l'assemblage des plantes devient encore plus facile. Ces accessoires ont été spécialement développés pour les différentes séries de bac à plantes Baq et sont de haute qualité.





LET'S CREATE



LINER COLLECTION

NL De universele Baq inzethoezen zijn beschikbaar in verschillende maten en gemaakt van zachte en flexibele kunststof, waardoor ze perfect aansluiten op iedere plantenbak. Een extra stevige rand zorgt voor het behoud van de vorm bij de grotere maten. Bovendien kun je met behulp van de handige snijrand de inzethoes eenvoudig op maat maken voor hydrocultuur.

DE Die universellen Baq EinsatzgefäÙe sind in verschiedenen Größen erhältlich und bestehen aus weichem, flexiblem Kunststoff, wodurch sie sich perfekt an jedes Pflanzgefäß anpassen. Durch den besonders soliden Rand bleibt auch bei den größeren Modellen die Form erhalten. Mithilfe der Schnittränder kann das Einsatz auf einfache Weise für die Hydrokultur passend gemacht werden.

EN The universal Baq liners are available in different sizes and are made of soft, flexible plastic, making them a perfect fit for any planter. An extra firm rim ensures that the larger sizes retain their shape. Also, the handy cutting edges help make the liner suitable for hydroculture.

FR Ces pochettes universelles sont disponibles en différentes tailles et fabriquées en plastique souple et flexible, ce qui les rend parfaitement compatibles avec n'importe quel bac à plantes. Un bord renforcé assure le maintien de la forme pour les grandes tailles. De plus, à l'aide des bords prédécoupés pratiques, tu peux facilement adapter la taille de la pochette pour l'hydroculture.



Photo: Liner round

B



D



A



C



A

ROUND

ART. CODE	↔	↗	⌊
6INZL1009	10	9	
6INZL1211	12	11	
6INZL1515	15	15	
6INZL2515	25	15	
6INZL1716	17	16	
6INZL2116	21	16	
6INZL1918	19	18	
6INZL3022	30	22	
6INZL3525	35	25	
6INZL4030	40	30	
6INZL4535	45	35	
6INZL5038	50	38	
6INZL3540	35	40	
6INZL5540	55	40	
6INZL4045	40	45	
6INZL6045	60	45	
6INZL7045	70	45	
6INZL6548	65	48	
6INZL8060	80	60	

B

SQUARE

ART. CODE	↔	↗	⌊
6INZL3230	32	32	30
6INZL3830	38	38	30
6INZL4835	48	48	35

C

RECTANGLE

ART. CODE	↔	↗	⌊
6INZL8020	80	20	20



D

BAQ LINER-DISPLAY

ART. CODE	↔	↗	⌊
6INZD0011	90	63	215

LINER COLLECTION

F



E



E

ROUND

ART. CODE	⊙	⊘	⊔
6BAQIR624	24	26	24
6BAQIR328	28	30	28
6BAQIR230	24	26	30
6BAQIR630	33	36	30
6BAQIR438	40	42	38
6BAQIR448	42	44	38

F

SQUARE

ART. CODE	↔	↙	⊔
6BAQIS624	26	26	24
6BAQIS431	34	34	31





Photo: Ecoline Rise Regular Partner Straight



Photo: Facets Ageless Couple



Photo: Gradient Balloon Matt Forest Green



Photo: Polystone Seaside Partner Natural



**Hydroflora GmbH
Objekt-Begrünung**

**Hugenottenallee 65-67
D-63263 Neu-Isenburg**

Tel.: +49 6102 – 25000-0

Fax: +49 6102 – 25000-50

info@hydroflora.de

www.hydroflora.de